

## VS1003 - MP3/WMA AUDIO CODEC

### Features

- Decodes MPEG 1 & 2 audio layer III (CBR +VBR +ABR); WMA 4.0/4.1/7/8/9 all profiles (5-384kbit/s); WAV (PCM + IMA ADPCM); General MIDI / SP-MIDI files
- Encodes IMA ADPCM from microphone or line input
- Streaming support for MP3 and WAV
- Bass and treble controls
- Operates with a single 12..13 MHz clock
- Internal PLL clock multiplier
- Low-power operation
- High-quality on-chip stereo DAC with no phase error between channels
- Stereo earphone driver capable of driving a 30Ω load
- Separate operating voltages for analog, digital and I/O
- 5.5 KiB On-chip RAM for user code / data
- Serial control and data interfaces
- Can be used as a slave co-processor
- SPI flash boot for special applications
- UART for debugging purposes
- New functions may be added with software and 4 GPIO pins

### Description

VS1003 is a single-chip MP3/WMA/MIDI audio decoder and ADPCM encoder. It contains a high-performance, proprietary low-power DSP processor core VS\_DSP<sup>4</sup>, working data memory, 5 KiB instruction RAM and 0.5 KiB data RAM for user applications, serial control and input data interfaces, 4 general purpose I/O pins, an UART, as well as a high-quality variable-sample-rate mono ADC and stereo DAC, followed by an earphone amplifier and a common buffer.

VS1003 receives its input bitstream through a serial input bus, which it listens to as a system slave. The input stream is decoded and passed through a digital volume control to an 18-bit oversampling, multi-bit, sigma-delta DAC. The decoding is controlled via a serial control bus. In addition to the basic decoding, it is possible to add application specific features, like DSP effects, to the user RAM memory.

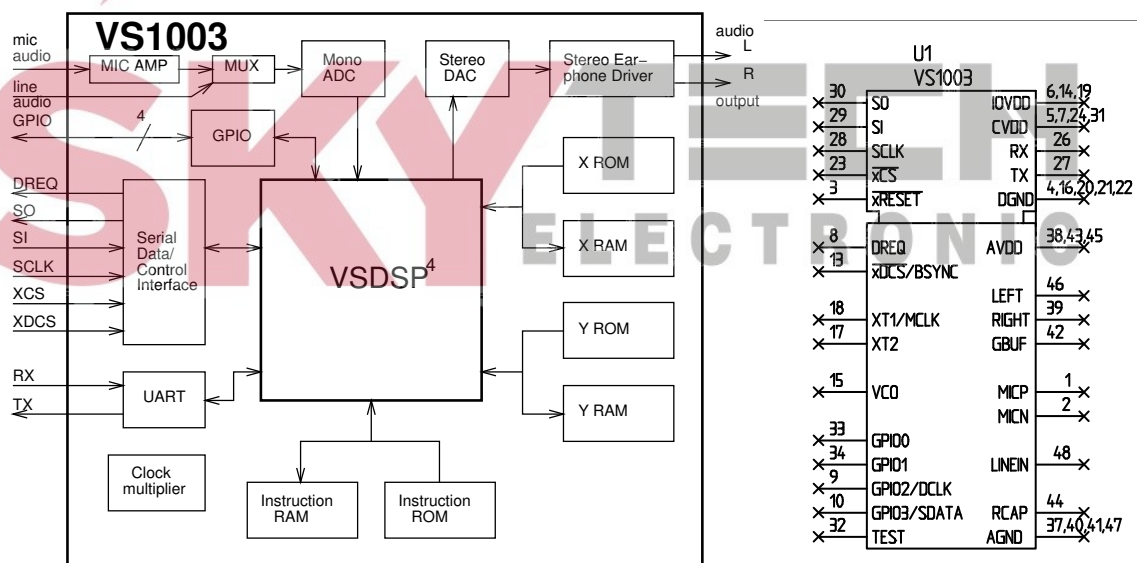

## Contents

<b>VS1003</b>	<b>1</b>
<b>Table of Contents</b>	<b>2</b>
<b>List of Figures</b>	<b>5</b>
<b>1 Licenses</b>	<b>6</b>
<b>2 Disclaimer</b>	<b>6</b>
<b>3 Definitions</b>	<b>6</b>
<b>4 Characteristics &amp; Specifications</b>	<b>7</b>
4.1 Absolute Maximum Ratings	7
4.2 Recommended Operating Conditions	7
4.3 Analog Characteristics	8
4.4 Power Consumption	9
4.5 Digital Characteristics	9
4.6 Switching Characteristics - Boot Initialization	9
4.7 Typical characteristics	10
4.7.1 Line input ADC	10
4.7.2 Microphone input ADC	10
4.7.3 RIGHT and LEFT outputs	11
<b>5 Packages and Pin Descriptions</b>	<b>12</b>
5.1 Packages	12
5.1.1 LQFP-48	12
5.1.2 BGA-49	12
5.2 LQFP-48 and BGA-49 Pin Descriptions	13
<b>6 Connection Diagram, LQFP-48</b>	<b>15</b>
<b>7 SPI Buses</b>	<b>16</b>
7.1 General	16
7.2 SPI Bus Pin Descriptions	16
7.2.1 VS10xx Native Modes (New Mode)	16
7.2.2 VS1001 Compatibility Mode	16
7.3 Data Request Pin DREQ	17
7.4 Serial Protocol for Serial Data Interface (SDI)	17
7.4.1 General	17
7.4.2 SDI in VS10xx Native Modes (New Mode, recommended)	17
7.4.3 SDI in VS1001 Compatibility Mode	18
7.4.4 Passive SDI Mode	18
7.5 Serial Protocol for Serial Command Interface (SCI)	18
7.5.1 General	18
7.5.2 SCI Read	19
7.5.3 SCI Write	19
7.6 SPI Timing Diagram	20
7.7 SPI Examples with SM_SDINEW and SM_SDISHARED set	21
7.7.1 Two SCI Writes	21

7.7.2	Two SDI Bytes . . . . .	21
7.7.3	SCI Operation in Middle of Two SDI Bytes . . . . .	22
<b>8</b>	<b>Functional Description</b>	<b>23</b>
8.1	Main Features . . . . .	23
8.2	Supported Audio Codecs . . . . .	23
8.2.1	Supported MP3 (MPEG layer III) Formats . . . . .	23
8.2.2	Supported WMA Formats . . . . .	24
8.2.3	Supported RIFF WAV Formats . . . . .	25
8.2.4	Supported MIDI Formats . . . . .	26
8.3	Data Flow of VS1003 . . . . .	27
8.4	Serial Data Interface (SDI) . . . . .	27
8.5	Serial Control Interface (SCI) . . . . .	28
8.6	SCI Registers . . . . .	28
8.6.1	SCI_MODE (RW) . . . . .	29
8.6.2	SCI_STATUS (RW) . . . . .	31
8.6.3	SCI_BASS (RW) . . . . .	31
8.6.4	SCI_CLOCKF (RW) . . . . .	32
8.6.5	SCI_DECODE_TIME (RW) . . . . .	33
8.6.6	SCI_AUDATA (RW) . . . . .	33
8.6.7	SCI_WRAM (RW) . . . . .	33
8.6.8	SCI_WRAMADDR (W) . . . . .	33
8.6.9	SCI_HDAT0 and SCI_HDAT1 (R) . . . . .	34
8.6.10	SCI_AIADDR (RW) . . . . .	35
8.6.11	SCI_VOL (RW) . . . . .	36
8.6.12	SCI_AICTRL[x] (RW) . . . . .	36
<b>9</b>	<b>Operation</b>	<b>37</b>
9.1	Clocking . . . . .	37
9.2	Hardware Reset . . . . .	37
9.3	Software Reset . . . . .	37
9.4	ADPCM Recording . . . . .	38
9.4.1	Activating ADPCM mode . . . . .	38
9.4.2	Reading IMA ADPCM Data . . . . .	38
9.4.3	Adding a RIFF Header . . . . .	39
9.4.4	Playing ADPCM Data . . . . .	40
9.4.5	Sample Rate Considerations . . . . .	40
9.4.6	Example Code . . . . .	40
9.5	SPI Boot . . . . .	42
9.6	Play/Decode . . . . .	42
9.7	Feeding PCM data . . . . .	42
9.8	SDI Tests . . . . .	43
9.8.1	Sine Test . . . . .	43
9.8.2	Pin Test . . . . .	44
9.8.3	Memory Test . . . . .	44
9.8.4	SCI Test . . . . .	44
<b>10</b>	<b>VS1003 Registers</b>	<b>45</b>
10.1	Who Needs to Read This Chapter . . . . .	45
10.2	The Processor Core . . . . .	45
10.3	VS1003 Memory Map . . . . .	45

10.4	SCI Registers . . . . .	45
10.5	Serial Data Registers . . . . .	46
10.6	DAC Registers . . . . .	47
10.7	GPIO Registers . . . . .	47
10.8	Interrupt Registers . . . . .	48
10.9	A/D Modulator Registers . . . . .	49
10.10	Watchdog . . . . .	50
10.10.1	Registers . . . . .	50
10.11	UART (Universal Asynchronous Receiver/Transmitter) . . . . .	51
10.11.1	Registers . . . . .	51
10.11.2	Status UARTx_STATUS . . . . .	51
10.11.3	Data UARTx_DATA . . . . .	52
10.11.4	Data High UARTx_DATAH . . . . .	52
10.11.5	Divider UARTx_DIV . . . . .	52
10.11.6	Interrupts and Operation . . . . .	53
10.12	Timers . . . . .	54
10.12.1	Registers . . . . .	54
10.12.2	Configuration TIMER_CONFIG . . . . .	54
10.12.3	Configuration TIMER_ENABLE . . . . .	55
10.12.4	Timer X Startvalue TIMER_Tx[L/H] . . . . .	55
10.12.5	Timer X Counter TIMER_TxCNT[L/H] . . . . .	55
10.12.6	Interrupts . . . . .	55
10.13	System Vector Tags . . . . .	56
10.13.1	Audiolnt, 0x20 . . . . .	56
10.13.2	Scilnt, 0x21 . . . . .	56
10.13.3	DataInt, 0x22 . . . . .	56
10.13.4	Modulnt, 0x23 . . . . .	56
10.13.5	TxInt, 0x24 . . . . .	57
10.13.6	RxInt, 0x25 . . . . .	57
10.13.7	Timer0Int, 0x26 . . . . .	57
10.13.8	Timer1Int, 0x27 . . . . .	57
10.13.9	UserCodec, 0x0 . . . . .	58
10.14	System Vector Functions . . . . .	58
10.14.1	WriteIRam(), 0x2 . . . . .	58
10.14.2	ReadIRam(), 0x4 . . . . .	58
10.14.3	DataBytes(), 0x6 . . . . .	59
10.14.4	GetDataByte(), 0x8 . . . . .	59
10.14.5	GetDataWords(), 0xa . . . . .	59
10.14.6	Reboot(), 0xc . . . . .	59
<b>11</b>	<b>Latest Document Version Changes</b> . . . . .	<b>60</b>
<b>12</b>	<b>Contact Information</b> . . . . .	<b>61</b>

## List of Figures

1	Measured ADC performance of the LINEIN pin. . . . .	10
2	Measured ADC performance of the MIC pins (differential). . . . .	10
3	Measured performance of RIGHT (or LEFT) output. . . . .	11
4	Typical spectrum of RIGHT (or LEFT) output. . . . .	11
5	Pin Configuration, LQFP-48. . . . .	12
6	Pin Configuration, BGA-49. . . . .	12
7	Typical Connection Diagram Using LQFP-48. . . . .	15
8	BSYNC Signal - one byte transfer. . . . .	18
9	BSYNC Signal - two byte transfer. . . . .	18
10	SCI Word Read . . . . .	19
11	SCI Word Write . . . . .	19
12	SPI Timing Diagram. . . . .	20
13	Two SCI Operations. . . . .	21
14	Two SDI Bytes. . . . .	21
15	Two SDI Bytes Separated By an SCI Operation. . . . .	22
16	Data Flow of VS1003. . . . .	27
17	ADPCM Frequency Responses with 8kHz sample rate. . . . .	30
18	User's Memory Map. . . . .	46
19	RS232 Serial Interface Protocol . . . . .	51





## 1 Licenses

VS1003 contains WMA decoding technology from Microsoft.

**This product is protected by certain intellectual property rights of Microsoft and cannot be used or further distributed without a license from Microsoft.**

## 2 Disclaimer

All properties and figures are subject to change.

## 3 Definitions

**ABR** Average BitRate. Bitrate of stream may vary locally, but will stay close to a given number when averaged over a longer time.

**B** Byte, 8 bits.

**b** Bit.

**CBR** Constant BitRate. Bitrate of stream will be the same for each compression block.

**CBUF** Headphone Common Buffer. Outputs DC voltage.

**GBUF** Same as CBUF.

**Ki** "Kibi" =  $2^{10}$  = 1024 (IEC 60027-2).

**Mi** "Mebi" =  $2^{20}$  = 1048576 (IEC 60027-2).

**SCI** Serial Control Interface, an SPI bus for VS1003 control.

**SDI** Serial Data Interface, an SPI bus for VS1003 bitstream data.

**VBR** Variable BitRate. Bitrate will vary depending on the complexity of the source material.

**VS\_DSP** VLSI Solution's DSP core.

**VSIDE** VLSI Solution's Integrated Development Environment.

**W** Word. In VS\_DSP, instruction words are 32 bits and data words are 16 bits wide.

### 4 Characteristics & Specifications

#### 4.1 Absolute Maximum Ratings

Parameter	Symbol	Min	Max	Unit
Analog Positive Supply	AVDD	-0.3	2.85	V
Digital Positive Supply	CVDD	-0.3	2.85	V
I/O Positive Supply	IOVDD	-0.3	3.6	V
Current at Any Digital Output			±50	mA
Voltage at Any Digital Input		-0.3	IOVDD+0.3 <sup>1</sup>	V
Operating Temperature		-40	+85	°C
Storage Temperature		-65	+150	°C

<sup>1</sup> Must not exceed 3.6 V

#### 4.2 Recommended Operating Conditions

Parameter	Symbol	Min	Typ	Max	Unit
Ambient Operating Temperature		-40		+85	°C
Analog and Digital Ground <sup>1</sup>	AGND DGND		0.0		V
Positive Analog	AVDD	2.6	2.8	2.85	V
Positive Digital	CVDD	2.4	2.5	2.85	V
I/O Voltage	IOVDD	CVDD-0.6V	2.8	3.6	V
Input Clock Frequency <sup>2</sup>	XTALI	12	12.288	13	MHz
Internal Clock Frequency	CLKI	12	36.864	52.0 <sup>4</sup>	MHz
Internal Clock Multiplier <sup>3</sup>		1.0×	3.0×	4.5×	
Master Clock Duty Cycle		40	50	60	%

<sup>1</sup> Must be connected together as close the device as possible for latch-up immunity.

<sup>2</sup> The maximum sample rate that can be played with correct speed is XTALI/256.

Thus, XTALI must be at least 12.288 MHz to be able to play 48 kHz at correct speed.

<sup>3</sup> Reset value is 1.0×. Recommended SC\_MULT=3.0×, SC\_ADD=1.0× (SCI\_CLOCKF=0x9000).

<sup>4</sup> 52.0 MHz is the maximum clock for the full CVDD range.

(4.0 × 12.288 MHz=49.152 MHz or 4.0 × 13.0 MHz=52.0 MHz)

### 4.3 Analog Characteristics

Unless otherwise noted: AVDD=2.85V, CVDD=2.5V, IOVDD=-2.8V, TA=-25...+70°C, XTALI=12.288MHz, DAC tested with 1307.894 Hz full-scale output sinewave, measurement bandwidth 20..20000 Hz, analog output load: LEFT to GBUF 30Ω, RIGHT to GBUF 30Ω. Microphone test amplitude 50 mVpp, f=1 kHz, Line input test amplitude 2.2 Vpp, f=1 kHz.

Parameter	Symbol	Min	Typ	Max	Unit
DAC Resolution			18		bits
Total Harmonic Distortion	THD		0.1	0.3	%
Dynamic Range (DAC unmuted, A-weighted)	IDR		>90		dB
S/N Ratio (full scale signal)	SNR	70 <sup>5</sup>	83 <sup>4</sup>		dB
Interchannel Isolation (Cross Talk)		50	75		dB
Interchannel Isolation (Cross Talk), with GBUF			40		dB
Interchannel Gain Mismatch		-0.5	±0.2	0.5	dB
Frequency Response		-0.1		0.1	dB
Full Scale Output Voltage (Peak-to-peak)		1.3	1.5 <sup>1</sup>	1.7	Vpp
Deviation from Linear Phase				5	°
Analog Output Load Resistance	AOLR	16	30 <sup>2</sup>		Ω
Analog Output Load Capacitance				100	pF
Microphone input amplifier gain	MICG		26		dB
Microphone input amplitude			50	140 <sup>3</sup>	mVpp AC
Microphone Total Harmonic Distortion	MTHD		0.02	0.10	%
Microphone S/N Ratio	MSNR	50 <sup>5</sup>	68		dB
Line input amplitude			2200	2800 <sup>3</sup>	mVpp AC
Line input Total Harmonic Distortion	LTHD		0.015	0.10	%
Line input S/N Ratio	LSNR	60 <sup>5</sup>	86		dB
Line and Microphone input impedances			100		kΩ

Typical values are measured of about 5000 devices of Lot 4234011, Week Code 0452.

<sup>1</sup> 3.0 volts can be achieved with +-to-+ wiring for mono difference sound.

<sup>2</sup> AOLR may be much lower, but below *Typical* distortion performance may be compromised.

<sup>3</sup> Above typical amplitude the Harmonic Distortion increases.

<sup>4</sup> Unweighted, A-weighted is about 3 dB better.

<sup>5</sup> Limit low due to noise level of production tester.



### 4.4 Power Consumption

Tested with an MPEG 1.0 Layer-3 128 kbit/s sample and generated sine. Output at full volume. XTALI 12.288 MHz. Internal clock multiplier 3.0×. CVDD = 2.5 V, AVDD = 2.8 V.

Parameter	Min	Typ	Max	Unit
Power Supply Consumption AVDD, Reset		0.6	5.0	μA
Power Supply Consumption CVDD, Reset, +25°C		3.7	40.0	μA
Power Supply Consumption CVDD, Reset, +85°C			200.0	μA
Power Supply Consumption AVDD, sine test, 30Ω + GBUF		36.9		mA
Power Supply Consumption CVDD, sine test		12.4		mA
Power Supply Consumption AVDD, no load		7.0		mA
Power Supply Consumption AVDD, output load 30Ω		10.9		mA
Power Supply Consumption AVDD, 30Ω + GBUF		16.1		mA
Power Supply Consumption CVDD		17.5		mA

### 4.5 Digital Characteristics

Parameter	Symbol	Min	Typ	Max	Unit
High-Level Input Voltage		0.7×IOVDD		IOVDD+0.3 <sup>1</sup>	V
Low-Level Input Voltage		-0.2		0.3×IOVDD	V
High-Level Output Voltage at I <sub>O</sub> = -1.0 mA		0.7×IOVDD			V
Low-Level Output Voltage at I <sub>O</sub> = 1.0 mA				0.3×IOVDD	V
Input Leakage Current		-1.0		1.0	μA
SPI Input Clock Frequency <sup>2</sup>				$\frac{CLKI}{7}$	MHz
Rise time of all output pins, load = 50 pF				50	ns

<sup>1</sup> Must not exceed 3.6V

<sup>2</sup> Value for SCI reads. SCI and SDI writes allow  $\frac{CLKI}{4}$ .

### 4.6 Switching Characteristics - Boot Initialization

Parameter	Symbol	Min	Max	Unit
XRESET active time		2		XTALI
XRESET inactive to software ready		16600	50000 <sup>1</sup>	XTALI
Power on reset, rise time to CVDD		10		V/s

<sup>1</sup> DREQ rises when initialization is complete. You should not send any data or commands before that.

### 4.7 Typical characteristics

#### 4.7.1 Line input ADC

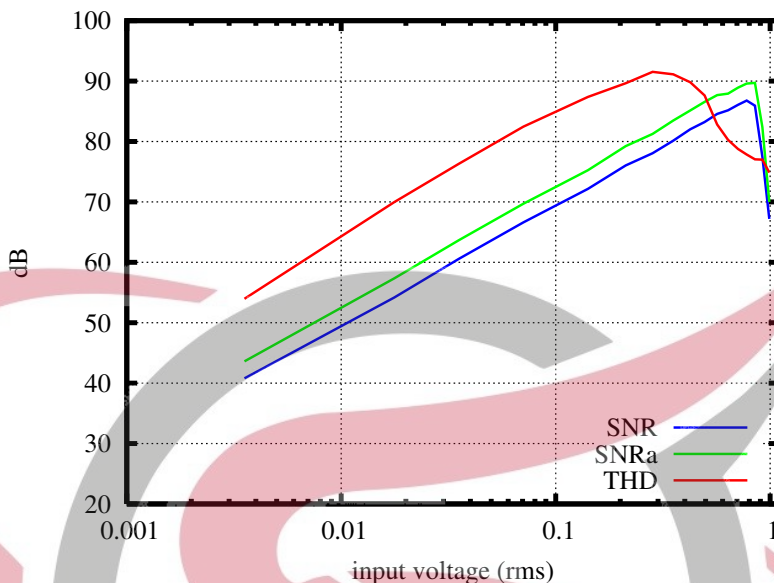

Figure 1: Measured ADC performance of the LINEIN pin.

Measured ADC performance of the LINEIN pin. X-axis is rms amplitude of 1 kHz sine input. Curves are unweighted signal-to-noise ratio (blue), A-weighted signal-to-noise ratio (green), and unweighted signal-to-distortion ratio (red). Sampling rate of ADC is 48 kHz (master clock 12.288 MHz), noise calculated from 0 to 20 kHz.

#### 4.7.2 Microphone input ADC

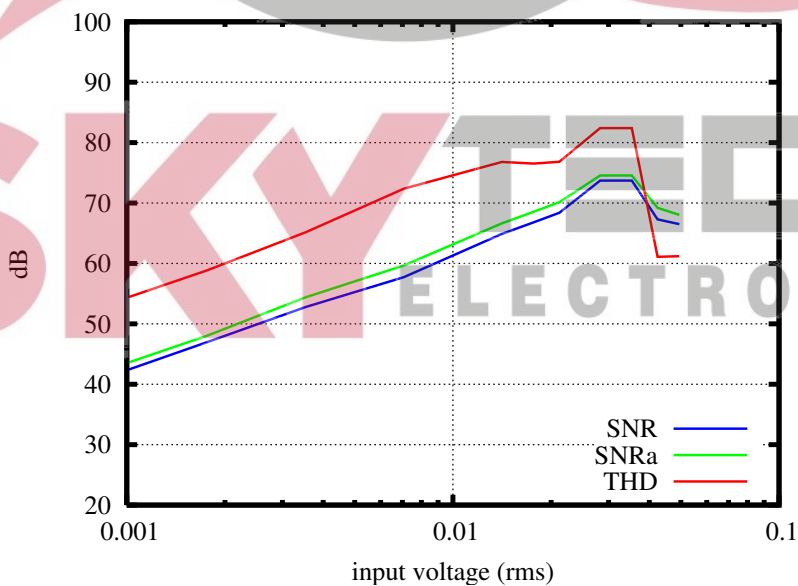

Figure 2: Measured ADC performance of the MIC pins (differential).

Measured ADC performance of the MIC pins (differential). Other settings same as in Fig. 1.

### 4.7.3 RIGHT and LEFT outputs

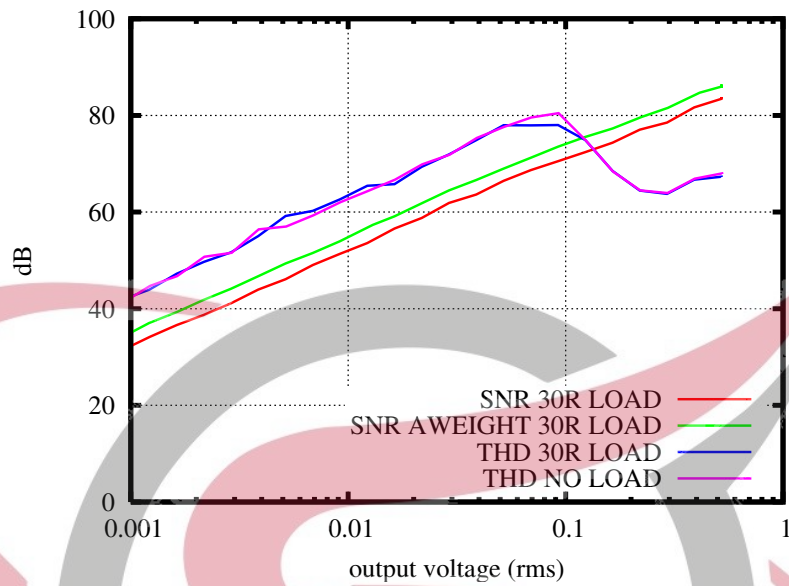

Figure 3: Measured performance of RIGHT (or LEFT) output.

Measured performance of RIGHT (or LEFT) output with 1 kHz generated sine. Sampling rate of DAC is 48 kHz (master clock 12.288 MHz), noise calculated from 0 to 20 kHz.

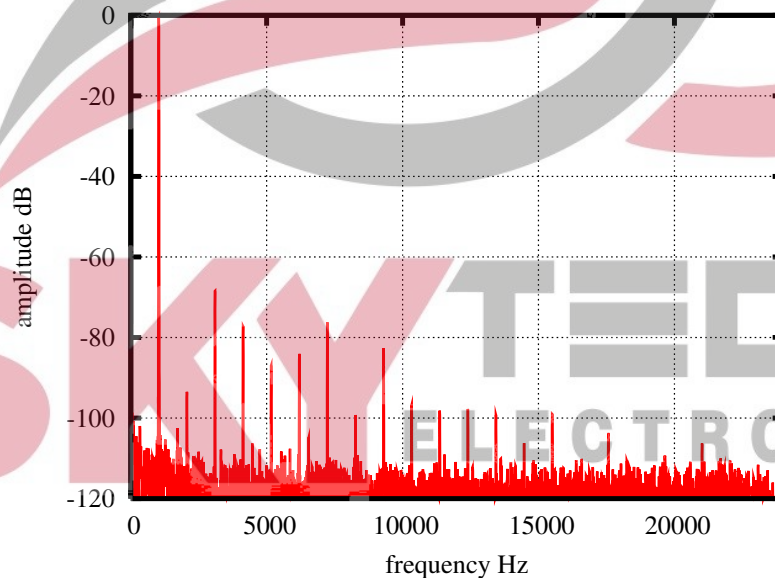

Figure 4: Typical spectrum of RIGHT (or LEFT) output.

Typical spectrum of RIGHT (or LEFT) output with maximum level and 30 Ohm load. Setup is the same as in Fig. 3.

## 5 Packages and Pin Descriptions

### 5.1 Packages

Both LPQFP-48 and BGA-49 are lead (Pb) free and also RoHS compliant packages. RoHS is a short name of *Directive 2002/95/EC on the restriction of the use of certain hazardous substances in electrical and electronic equipment*.

#### 5.1.1 LQFP-48

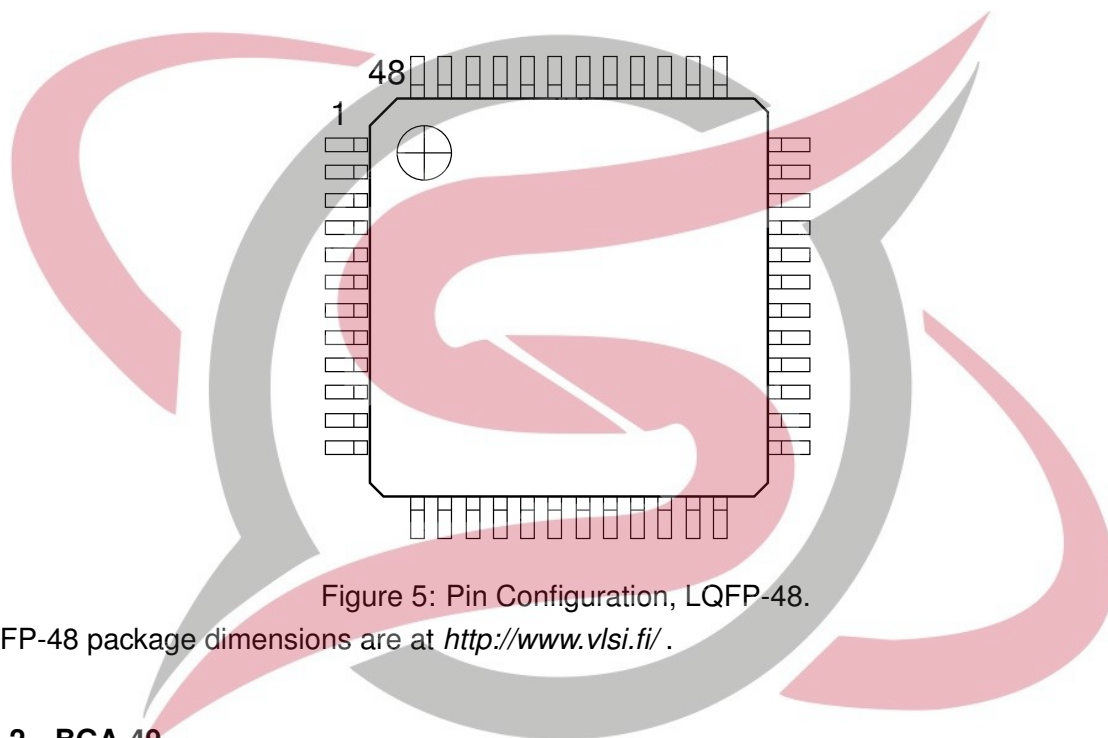

Figure 5: Pin Configuration, LQFP-48.

LQFP-48 package dimensions are at <http://www.vlsi.fi/>.

#### 5.1.2 BGA-49

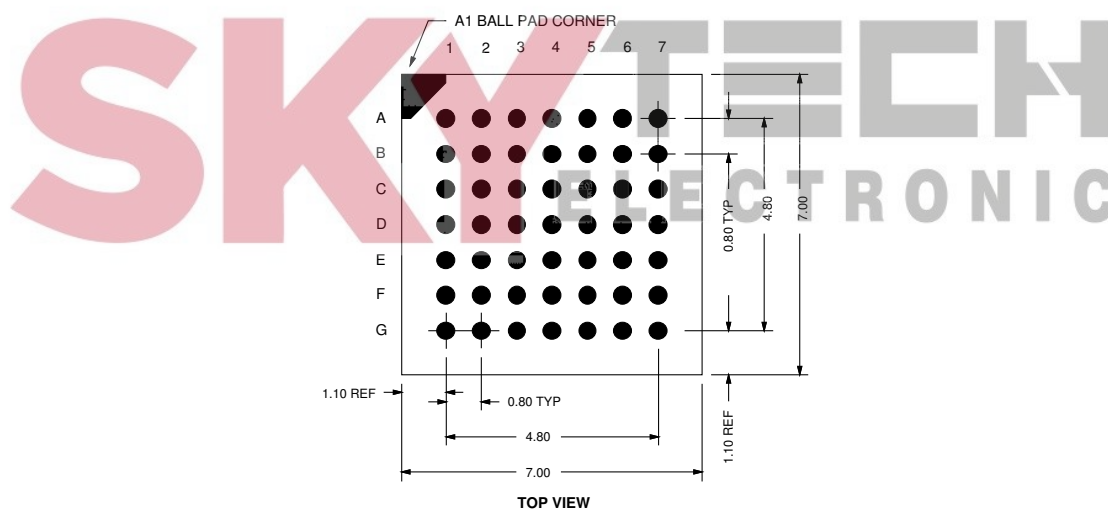

Figure 6: Pin Configuration, BGA-49.

BGA-49 package dimensions are at <http://www.vlsi.fi/>.

### 5.2 LQFP-48 and BGA-49 Pin Descriptions

Pin Name	LQFP-48 Pin	BGA49 Ball	Pin Type	Function
MICP	1	C3	AI	Positive differential microphone input, self-biasing
MICN	2	C2	AI	Negative differential microphone input, self-biasing
XRESET	3	B1	DI	Active low asynchronous reset
DGND0	4	D2	DGND	Core & I/O ground
CVDD0	5	C1	CPWR	Core power supply
IOVDD0	6	D3	IOPWR	I/O power supply
CVDD1	7	D1	CPWR	Core power supply
DREQ	8	E2	DO	Data request, input bus
GPIO2 / DCLK <sup>1</sup>	9	E1	DIO	General purpose IO 2 / serial input data bus clock
GPIO3 / SDATA <sup>1</sup>	10	F2	DIO	General purpose IO 3 / serial data input
XDCS / BSYNC <sup>1</sup>	13	E3	DI	Data chip select / byte sync
IOVDD1	14	F3	IOPWR	I/O power supply
VCO	15	G2	DO	For testing only (Clock VCO output)
DGND1	16	F4	DGND	Core & I/O ground
XTALO	17	G3	AO	Crystal output
XTALI	18	E4	AI	Crystal input
IOVDD2	19	G4	IOPWR	I/O power supply
IOVDD3		F5	IOPWR	I/O power supply
DGND2	20		DGND	Core & I/O ground
DGND3	21	G5	DGND	Core & I/O ground
DGND4	22	F6	DGND	Core & I/O ground
XCS	23	G6	DI	Chip select input (active low)
CVDD2	24	G7	CPWR	Core power supply
RX	26	E6	DI	UART receive, connect to IOVDD if not used
TX	27	F7	DO	UART transmit
SCLK	28	D6	DI	Clock for serial bus
SI	29	E7	DI	Serial input
SO	30	D5	DO3	Serial output
CVDD3	31	D7	CPWR	Core power supply
TEST	32	C6	DI	Reserved for test, connect to IOVDD
GPIO0 / SPIBOOT	33	C7	DIO	General purpose IO 0 / SPIBOOT, use 100 k $\Omega$ pull-down resistor <sup>2</sup>
GPIO1	34	B6	DIO	General purpose IO 1
AGND0	37	C5	APWR	Analog ground, low-noise reference
AVDD0	38	B5	APWR	Analog power supply
RIGHT	39	A6	AO	Right channel output
AGND1	40	B4	APWR	Analog ground
AGND2	41	A5	APWR	Analog ground
GBUF	42	C4	AO	Common buffer for headphones
AVDD1	43	A4	APWR	Analog power supply
RCAP	44	B3	AIO	Filtering capacitance for reference
AVDD2	45	A3	APWR	Analog power supply
LEFT	46	B2	AO	Left channel output
AGND3	47	A2	APWR	Analog ground
LINEIN	48	A1	AI	Line input

<sup>1</sup> First pin function is active in New Mode, latter in Compatibility Mode.

<sup>2</sup> Unless pull-down resistor is used, SPI Boot is tried. See Chapter 9.5 for details.



Pin types:

Type	Description	Type	Description
DI	Digital input, CMOS Input Pad	AO	Analog output
DO	Digital output, CMOS Input Pad	AIO	Analog input/output
DIO	Digital input/output	APWR	Analog power supply pin
DO3	Digital output, CMOS Tri-stated Output Pad	DGND	Core or I/O ground pin
AI	Analog input	CPWR	Core power supply pin
		IOPWR	I/O power supply pin

In BGA-49, no-connect balls are A7, B7, D4, E5, F1, G1.

In LQFP-48, no-connect pins are 11, 12, 25, 35, 36.



## 6 Connection Diagram, LQFP-48

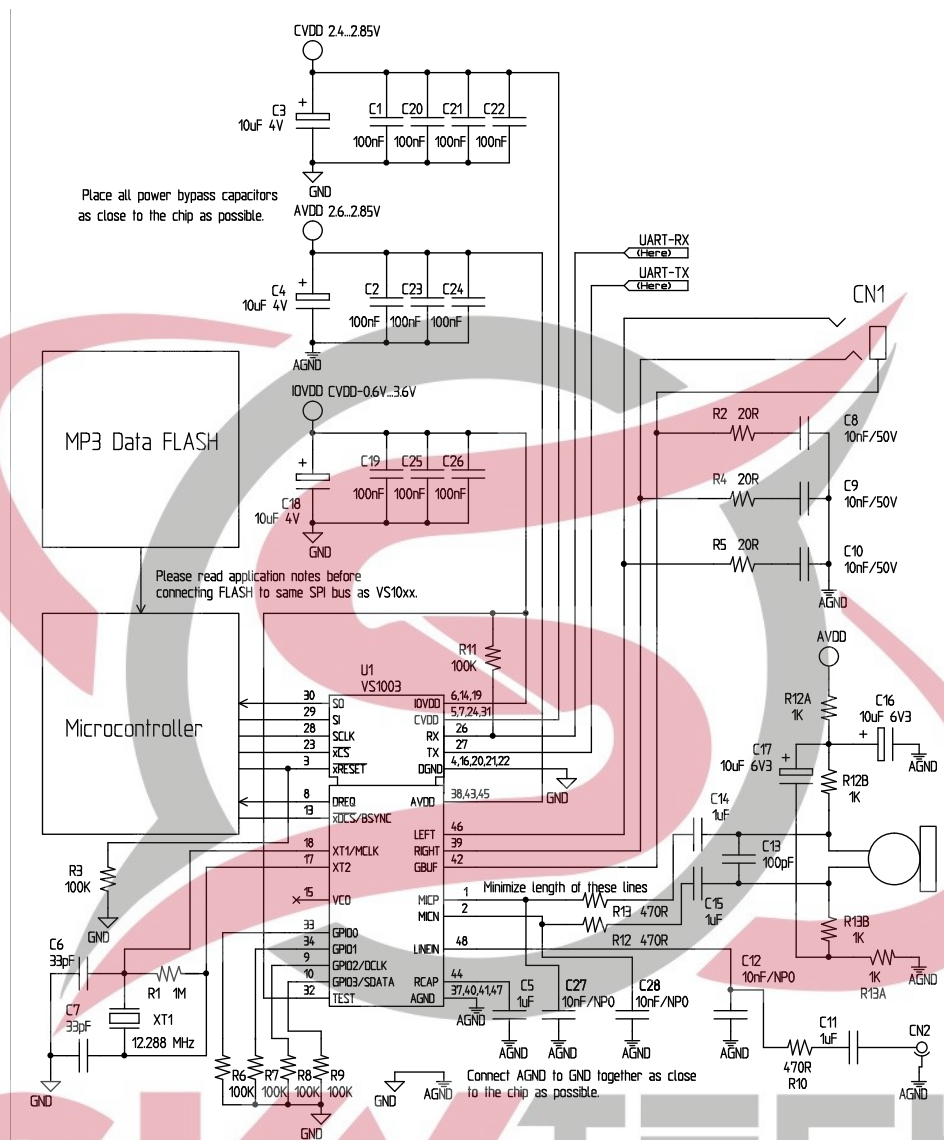

Figure 7: Typical Connection Diagram Using LQFP-48.

The common buffer GBUF can be used for common voltage (1.24 V) for earphones. This will eliminate the need for large isolation capacitors on line outputs, and thus the audio output pins from VS1003 may be connected directly to the earphone connector.

GBUF must NOT be connected to ground under any circumstances. If GBUF is not used, LEFT and RIGHT must be provided with coupling capacitors. To keep GBUF stable, you should always have the resistor and capacitor even when GBUF is not used. See application notes for details.

Unused GPIO pins should have a pull-down resistor.

If UART is not used, RX should be connected to IOVDD and TX be unconnected.

Do not connect any external load to XTALO.

Note: This connection assumes SM\_SDINEW is active (see Chapter 8.6.1). If also SM\_SDISHARE is used, xDCS should be tied high (see Chapter 7.2.1).

## 7 SPI Buses

### 7.1 General

The SPI Bus - that was originally used in some Motorola devices - has been used for both VS1003's Serial Data Interface SDI (Chapters 7.4 and 8.4) and Serial Control Interface SCI (Chapters 7.5 and 8.5).

### 7.2 SPI Bus Pin Descriptions

#### 7.2.1 VS10xx Native Modes (New Mode)

These modes are active on VS1003 when SM\_SDINEW is set to 1 (default at startup). DCLK and SDATA are not used for data transfer and they can be used as general-purpose I/O pins (GPIO2 and GPIO3). BSYNC function changes to data interface chip select (XDCS).

SDI Pin	SCI Pin	Description
XDCS	XCS	Active low chip select input. A high level forces the serial interface into standby mode, ending the current operation. A high level also forces serial output (SO) to high impedance state. If SM_SDISHARE is 1, pin XDCS is not used, but the signal is generated internally by inverting XCS.
SCK		Serial clock input. The serial clock is also used internally as the master clock for the register interface. SCK can be gated or continuous. In either case, the first rising clock edge after XCS has gone low marks the first bit to be written.
SI		Serial input. If a chip select is active, SI is sampled on the rising CLK edge.
-	SO	Serial output. In reads, data is shifted out on the falling SCK edge. In writes SO is at a high impedance state.

#### 7.2.2 VS1001 Compatibility Mode

This mode is active when SM\_SDINEW is set to 0. In this mode, DCLK, SDATA and BSYNC are active.

SDI Pin	SCI Pin	Description
-	XCS	Active low chip select input. A high level forces the serial interface into standby mode, ending the current operation. A high level also forces serial output (SO) to high impedance state.
BSYNC	-	SDI data is synchronized with a rising edge of BSYNC.
DCLK	SCK	Serial clock input. The serial clock is also used internally as the master clock for the register interface. SCK can be gated or continuous. In either case, the first rising clock edge after XCS has gone low marks the first bit to be written.
SDATA	SI	Serial input. SI is sampled on the rising SCK edge, if XCS is low.
-	SO	Serial output. In reads, data is shifted out on the falling SCK edge. In writes SO is at a high impedance state.

## 7.3 Data Request Pin DREQ

The DREQ pin/signal is used to signal if VS1003's FIFO is capable of receiving data. If DREQ is high, VS1003 can take at least 32 bytes of SDI data or one SCI command. When these criteria are not met, DREQ is turned low, and the sender should stop transferring new data.

Because of the 32-byte safety area, the sender may send up to 32 bytes of SDI data at a time without checking the status of DREQ, making controlling VS1003 easier for low-speed microcontrollers.

Note: DREQ may turn low or high at any time, even during a byte transmission. Thus, DREQ should only be used to decide whether to send more bytes. It should not abort a transmission that has already started.

Note: In VS10XX products up to VS1002, DREQ was only used for SDI. In VS1003 DREQ is also used to tell the status of SCI.

There are cases when you still want to send SCI commands when DREQ is low. Because DREQ is shared between SDI and SCI, you can not determine if a SCI command has been executed if SDI is not ready to receive. In this case you need a long enough delay after every SCI command to make certain none of them is missed. The SCI Registers table in section 8.6 gives the worst-case handling time for each SCI register write.

## 7.4 Serial Protocol for Serial Data Interface (SDI)

### 7.4.1 General

The serial data interface operates in slave mode so DCLK signal must be generated by an external circuit.

Data (SDATA signal) can be clocked in at either the rising or falling edge of DCLK (Chapter 8.6).

VS1003 assumes its data input to be byte-synchronized. SDI bytes may be transmitted either MSb or LSb first, depending of contents of SCI\_MODE (Chapter 8.6.1).

The firmware is able to accept the maximum bitrate the SDI supports.

### 7.4.2 SDI in VS10xx Native Modes (New Mode, recommended)

In VS10xx native modes (SM\_NEWMODE is 1), byte synchronization is achieved by XDACS. The state of XDACS may not change while a data byte transfer is in progress. To always maintain data synchronization even if there may be glitches in the boards using VS1003, it is recommended to turn XDACS every now and then, for instance once after every flash data block or a few kilobytes, just to keep sure the host and VS1003 are in sync.

If SM\_SDISHARE is 1, the XDACS signal is internally generated by inverting the XCS input.

For new designs, using VS10xx native modes are recommended.



### 7.4.3 SDI in VS1001 Compatibility Mode

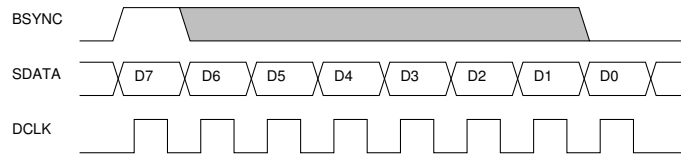

Figure 8: BSYNC Signal - one byte transfer.

When VS1003 is running in VS1001 compatibility mode, a BSYNC signal must be generated to ensure correct bit-alignment of the input bitstream. The first DCLK sampling edge (rising or falling, depending on selected polarity), during which the BSYNC is high, marks the first bit of a byte (LSB, if LSB-first order is used, MSB, if MSB-first order is used). If BSYNC is '1' when the last bit is received, the receiver stays active and next 8 bits are also received.

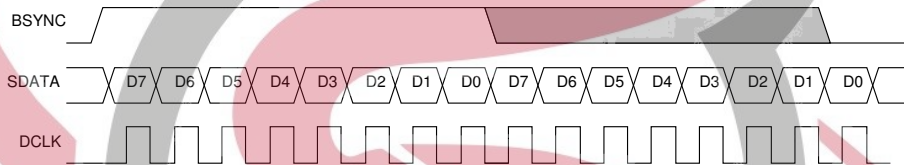

Figure 9: BSYNC Signal - two byte transfer.

### 7.4.4 Passive SDI Mode

If SM\_NEWMODE is 0 and SM\_SDISHARE is 1, the operation is otherwise like the VS1001 compatibility mode, but bits are only received while the BSYNC signal is '1'. Rising edge of BSYNC is still used for synchronization.

## 7.5 Serial Protocol for Serial Command Interface (SCI)

### 7.5.1 General

The serial bus protocol for the Serial Command Interface SCI (Chapter 8.5) consists of an instruction byte, address byte and one 16-bit data word. Each read or write operation can read or write a single register. Data bits are read at the rising edge, so the user should update data at the falling edge. Bytes are always send MSb first. XCS should be low for the full duration of the operation, but you can have pauses between bits if needed.

The operation is specified by an 8-bit instruction opcode. The supported instructions are read and write. See table below.

Instruction		
Name	Opcode	Operation
READ	0b0000 0011	Read data
WRITE	0b0000 0010	Write data

Note: VS1003 sets DREQ low after each SCI operation. The duration depends on the operation. It is not allowed to start a new SCI/SDI operation before DREQ is high again.



## 7.5.2 SCI Read

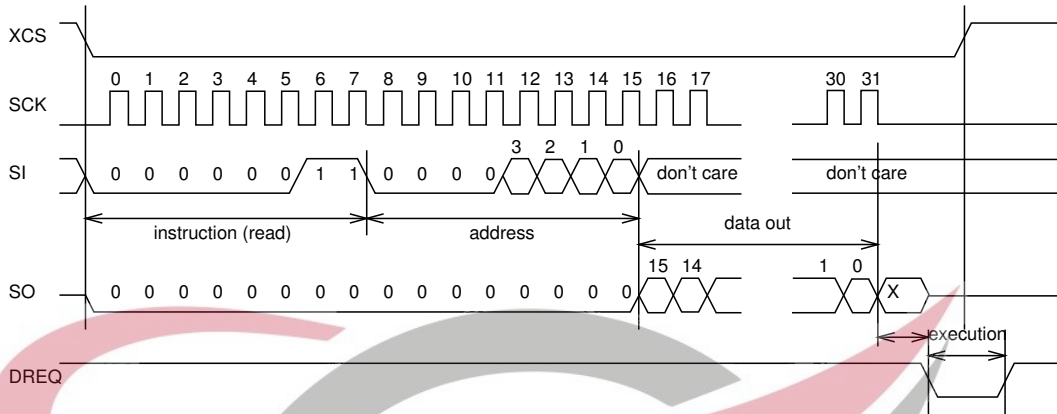

Figure 10: SCI Word Read

VS1003 registers are read from using the following sequence, as shown in Figure 10. First, XCS line is pulled low to select the device. Then the READ opcode (0x3) is transmitted via the SI line followed by an 8-bit word address. After the address has been read in, any further data on SI is ignored by the chip. The 16-bit data corresponding to the received address will be shifted out onto the SO line.

XCS should be driven high after data has been shifted out.

DREQ is driven low for a short while when in a read operation by the chip. This is a very short time and doesn't require special user attention.

## 7.5.3 SCI Write

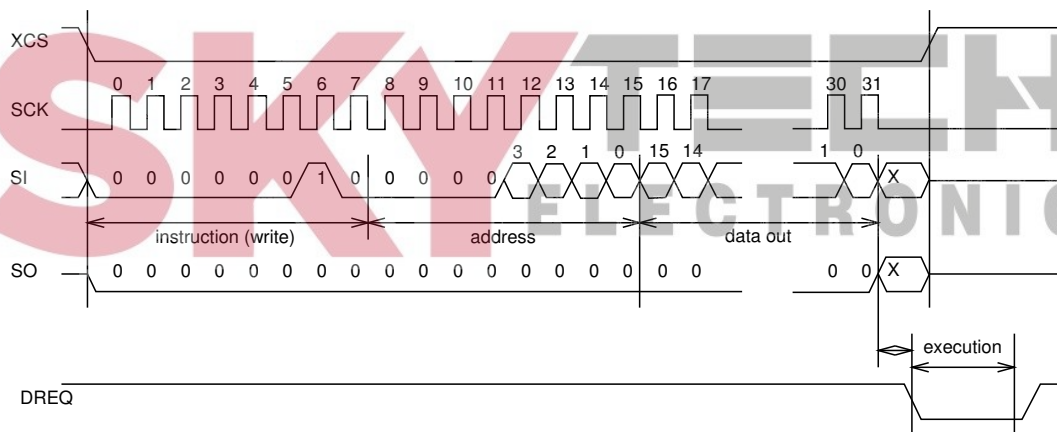

Figure 11: SCI Word Write

VS1003 registers are written from using the following sequence, as shown in Figure 11. First, XCS line is pulled low to select the device. Then the WRITE opcode (0x2) is transmitted via the SI line followed by an 8-bit word address.

After the word has been shifted in and the last clock has been sent, XCS should be pulled high to end the WRITE sequence.

After the last bit has been sent, DREQ is driven low for the duration of the register update, marked “execution” in the figure. The time varies depending on the register and its contents (see table in Chapter 8.6 for details). If the maximum time is longer than what it takes from the microcontroller to feed the next SCI command or SDI byte, it is not allowed to finish a new SCI/SDI operation before DREQ has risen up again.

## 7.6 SPI Timing Diagram

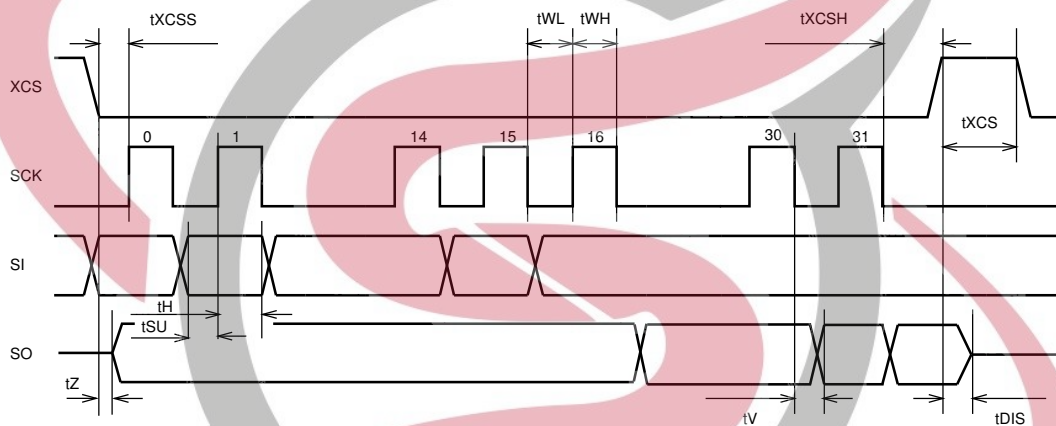

Figure 12: SPI Timing Diagram.

Symbol	Min	Max	Unit
tXCSS	5		ns
tSU	0		ns
tH	2		CLKI cycles
tZ	0		ns
tWL	2		CLKI cycles
tWH	2		CLKI cycles
tV	2 (+ 25ns <sup>1</sup> )		CLKI cycles
tXCSH	1		CLKI
tXCS	2		CLKI cycles
tDIS		10	ns

<sup>1</sup> 25ns is when pin loaded with 100pF capacitance. The time is shorter with lower capacitance.

Note: As tWL and tWH, as well as tH require at least 2 clock cycles, the maximum speed for the SPI bus that can easily be used with asynchronous clocks is 1/7 of VS1003's internal clock speed CLKI.

Note: Although the timing is derived from the internal clock CLKI, the system always starts up in 1.0× mode, thus CLKI=XTALI.

## 7.7 SPI Examples with SM\_SDINew and SM\_SDISHARED set

### 7.7.1 Two SCI Writes

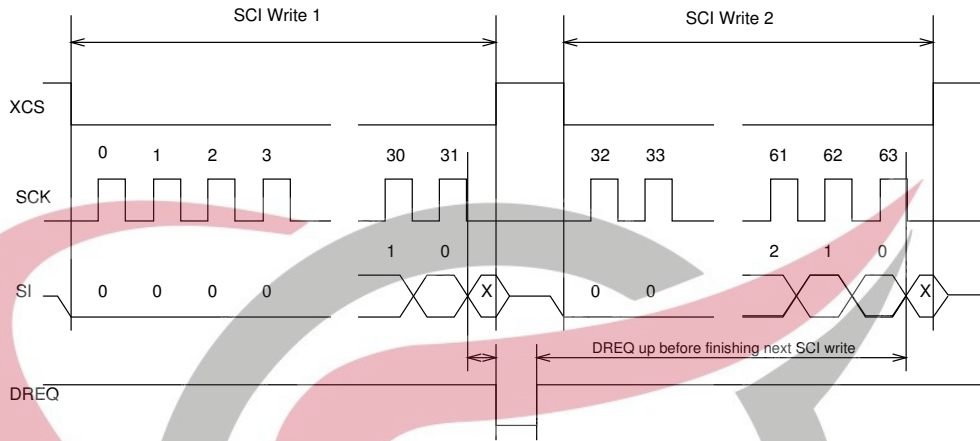

Figure 13: Two SCI Operations.

Figure 13 shows two consecutive SCI operations. Note that xCS *must* be raised to inactive state between the writes. Also DREQ must be respected as shown in the figure.

### 7.7.2 Two SDI Bytes

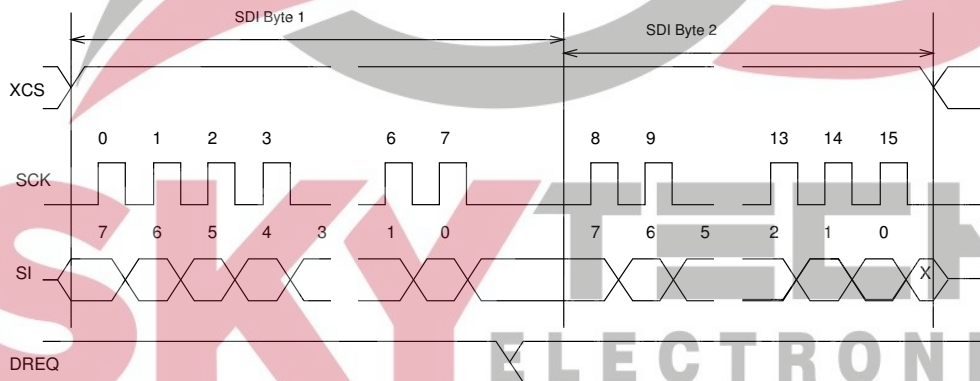

Figure 14: Two SDI Bytes.

SDI data is synchronized with a raising edge of xCS as shown in Figure 14. However, every byte doesn't need separate synchronization.

### 7.7.3 SCI Operation in Middle of Two SDI Bytes

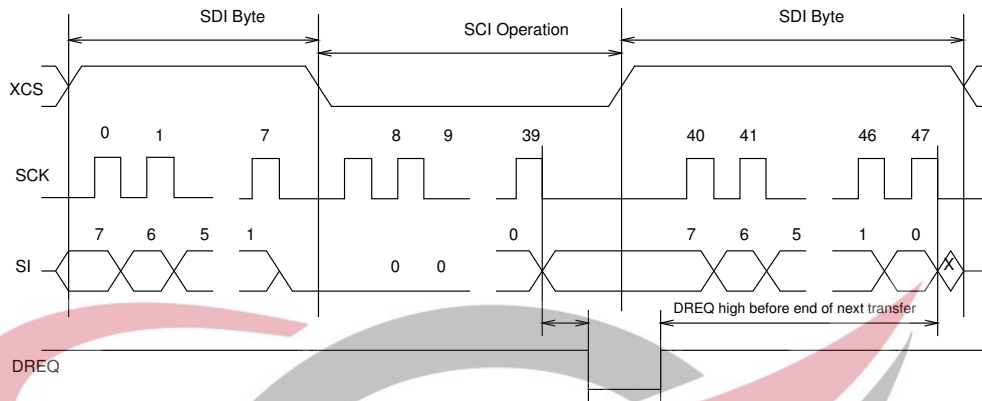

Figure 15: Two SDI Bytes Separated By an SCI Operation.

Figure 15 shows how an SCI operation is embedded in between SDI operations. xCS edges are used to synchronize both SDI and SCI. Remember to respect DREQ as shown in the figure.

## 8 Functional Description

### 8.1 Main Features

VS1003 is based on a proprietary digital signal processor, VS\_DSP. It contains all the code and data memory needed for MP3, WMA and WAV PCM + ADPCM audio decoding, MIDI synthesizer, together with serial interfaces, a multirate stereo audio DAC and analog output amplifiers and filters. Also ADPCM audio encoding is supported using a microphone amplifier and A/D converter. A UART is provided for debugging purposes.

### 8.2 Supported Audio Codecs

Conventions	
Mark	Description
+	Format is supported
-	Format exists but is not supported
	Format doesn't exist

#### 8.2.1 Supported MP3 (MPEG layer III) Formats

MPEG 1.0<sup>1</sup>:

Samplerate / Hz	Bitrate / kbit/s													
	32	40	48	56	64	80	96	112	128	160	192	224	256	320
48000	+	+	+	+	+	+	+	+	+	+	+	+	+	+
44100	+	+	+	+	+	+	+	+	+	+	+	+	+	+
32000	+	+	+	+	+	+	+	+	+	+	+	+	+	+

MPEG 2.0<sup>1</sup>:

Samplerate / Hz	Bitrate / kbit/s													
	8	16	24	32	40	48	56	64	80	96	112	128	144	160
24000	+	+	+	+	+	+	+	+	+	+	+	+	+	+
22050	+	+	+	+	+	+	+	+	+	+	+	+	+	+
16000	+	+	+	+	+	+	+	+	+	+	+	+	+	+

MPEG 2.5<sup>1 2</sup>:

Samplerate / Hz	Bitrate / kbit/s													
	8	16	24	32	40	48	56	64	80	96	112	128	144	160
12000	+	+	+	+	+	+	+	+	+	+	+	+	+	+
11025	+	+	+	+	+	+	+	+	+	+	+	+	+	+
8000	+	+	+	+	+	+	+	+	+	+	+	+	+	+

<sup>1</sup> Also all variable bitrate (VBR) formats are supported.

<sup>2</sup> Incompatibilities may occur because MPEG 2.5 is not a standard format.



### 8.2.2 Supported WMA Formats

Windows Media Audio codec versions 2, 7, 8, and 9 are supported. All WMA profiles (L1, L2, and L3) are supported. Previously streams were separated into Classes 1, 2a, 2b, and 3. WMA 9 Professional and WMA 9 Lossless are not supported. The decoder has passed Microsoft's conformance testing program.

WMA 4.0 / 4.1:

Samplerate / Hz	Bitrate / kbit/s																
	5	6	8	10	12	16	20	22	32	40	48	64	80	96	128	160	192
8000	+	+	+		+												
11025			+	+													
16000				+	+	+	+										
22050						+	+	+	+								
32000							+	+	+	+	+	+					
44100									+		+	+	+	+	+	+	+
48000															+	+	

WMA 7:

Samplerate / Hz	Bitrate / kbit/s																
	5	6	8	10	12	16	20	22	32	40	48	64	80	96	128	160	192
8000	+	+	+		+												
11025			+	+													
16000				+	+	+	+										
22050						+	+	+	+								
32000							+		+	+	+						
44100									+		+	+	+	+	+	+	+
48000															+	+	

WMA 8:

Samplerate / Hz	Bitrate / kbit/s																
	5	6	8	10	12	16	20	22	32	40	48	64	80	96	128	160	192
8000	+	+	+		+												
11025			+	+													
16000				+	+	+	+										
22050						+	+	+	+								
32000							+		+	+	+						
44100									+		+	+	+	+	+	+	+
48000												+	+	+	+	+	+

WMA 9:

Samplerate / Hz	Bitrate / kbit/s																		
	5	6	8	10	12	16	20	22	32	40	48	64	80	96	128	160	192	256	320
8000	+	+	+		+														
11025			+	+															
16000				+	+	+	+												
22050						+	+	+	+										
32000							+		+	+	+								
44100							+		+		+	+	+	+	+	+	+	+	+
48000												+		+	+	+	+		

In addition to these expected WMA decoding profiles, all other bitrate and samplerate combinations are supported, including variable bitrate WMA streams. Note that WMA does not consume the bitstream as evenly as MP3, so you need a higher peak transfer capability for clean playback at the same bitrate.

## 8.2.3 Supported RIFF WAV Formats

The most common RIFF WAV subformats are supported.

Format	Name	Supported	Comments
0x01	PCM	+	16 and 8 bits, any sample rate $\leq$ 48kHz
0x02	ADPCM	-	
0x03	IEEE_FLOAT	-	
0x06	ALAW	-	
0x07	MULAW	-	
0x10	OKI_ADPCM	-	
0x11	IMA_ADPCM	+	Any sample rate $\leq$ 48kHz
0x15	DIGISTD	-	
0x16	DIGIFIX	-	
0x30	DOLBY_AC2	-	
0x31	GSM610	-	
0x3b	ROCKWELL_ADPCM	-	
0x3c	ROCKWELL_DIGITALK	-	
0x40	G721_ADPCM	-	
0x41	G728_CELP	-	
0x50	MPEG	-	
0x55	MPEGLAYER3	+	For supported MP3 modes, see Chapter 8.2.1
0x64	G726_ADPCM	-	
0x65	G722_ADPCM	-	

## 8.2.4 Supported MIDI Formats

General MIDI and SP-MIDI format 0 files are played. Format 1 and 2 files must be converted to format 0 by the user. The maximum simultaneous polyphony is 40. Actual polyphony depends on the internal clock rate (which is user-selectable), the instruments used, and the possible postprocessing effects enabled, such as bass and treble enhancers. The polyphony restriction algorithm makes use of the SP-MIDI MIP table, if present.

36.86 MHz ( $3.0 \times$  input clock) achieves 16-26 simultaneous sustained notes. The instantaneous amount of notes can be larger. 36 MHz is a fair compromise between power consumption and quality, but higher clocks can be used to increase polyphony.

VS1003b implements 36 distinct instruments. Each melodic, effect, and percussion instrument is mapped into one of these instruments.

VS1003b		
Melodic	Effect	Percussion
piano	reverse cymbal	bass drum
vibraphone	guitar fret noise	snare
organ	breath	closed hihat
guitar	seashore	open hihat
distortion guitar	bird tweet	high tom
bass	telephone	low tom
violin	helicopter	crash cymbal 2
strings	applause	ride cymbal
trumpet	gunshot	tambourine
sax		high conga
flute		low conga
lead		maracas
pad		claves
steeldrum		

## 8.3 Data Flow of VS1003

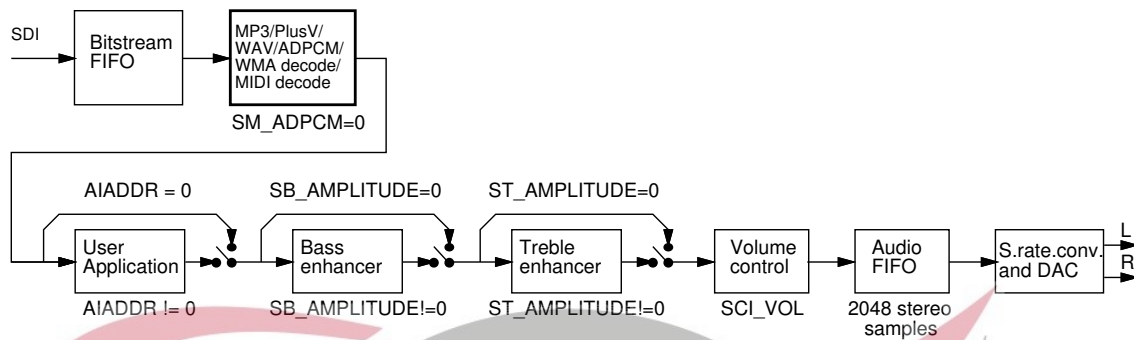

Figure 16: Data Flow of VS1003.

First, depending on the audio data, and provided ADPCM encoding mode is not set, MP3, WMA, PCM WAV, IMA ADPCM WAV, or MIDI data is received and decoded from the SDI bus.

After decoding, if SCI\_AIADDR is non-zero, application code is executed from the address pointed to by that register. For more details, see Application Notes for VS10XX.

Then data may be sent to the Bass and Treble Enhancer depending on the SCI\_BASS register.

After that the signal is fed to the volume control unit, which also copies the data to the Audio FIFO.

The Audio FIFO holds the data, which is read by the Audio interrupt (Chapter 10.13.1) and fed to the sample rate converter and DACs. The size of the audio FIFO is 2048 stereo ( $2 \times 16$ -bit) samples, or 8 KiB.

The sample rate converter converts all different sample rates to  $XTALI/2$ , or 128 times the highest usable sample rate. This removes the need for complex PLL-based clocking schemes and allows almost unlimited sample rate accuracy with one fixed input clock frequency. With a 12.288 MHz clock, the DA converter operates at  $128 \times 48$  kHz, i.e. 6.144 MHz, and creates a stereo in-phase analog signal. The oversampled output is low-pass filtered by an on-chip analog filter. This signal is then forwarded to the earphone amplifier.

## 8.4 Serial Data Interface (SDI)

The serial data interface is meant for transferring compressed MP3 or WMA data, WAV PCM and ADPCM data as well as MIDI data.

If the input of the decoder is invalid or it is not received fast enough, analog outputs are automatically muted.

Also several different tests may be activated through SDI as described in Chapter 9.

## 8.5 Serial Control Interface (SCI)

The serial control interface is compatible with the SPI bus specification. Data transfers are always 16 bits. VS1003 is controlled by writing and reading the registers of the interface.

The main controls of the control interface are:

- control of the operation mode, clock, and builtin effects
- access to status information and header data
- access to encoded digital data
- uploading user programs

## 8.6 SCI Registers

SCI registers, prefix SCI_					
Reg	Type	Reset	Time <sup>1</sup>	Abbrev[bits]	Description
0x0	rw	0x800	70 CLKI <sup>4</sup>	MODE	Mode control
0x1	rw	0x3C <sup>3</sup>	40 CLKI	STATUS	Status of VS1003
0x2	rw	0	2100 CLKI	BASS	Built-in bass/treble enhancer
0x3	rw	0	11000 XTALI <sup>5</sup>	CLOCKF	Clock freq + multiplier
0x4	rw	0	40 CLKI	DECODE_TIME	Decode time in seconds
0x5	rw	0	3200 CLKI	AUDATA	Misc. audio data
0x6	rw	0	80 CLKI	WRAM	RAM write/read
0x7	rw	0	80 CLKI	WRAMADDR	Base address for RAM write/read
0x8	r	0	-	HDATA0	Stream header data 0
0x9	r	0	-	HDATA1	Stream header data 1
0xA	rw	0	3200 CLKI <sup>2</sup>	AIADDR	Start address of application
0xB	rw	0	2100 CLKI	VOL	Volume control
0xC	rw	0	50 CLKI <sup>2</sup>	AICTRL0	Application control register 0
0xD	rw	0	50 CLKI <sup>2</sup>	AICTRL1	Application control register 1
0xE	rw	0	50 CLKI <sup>2</sup>	AICTRL2	Application control register 2
0xF	rw	0	50 CLKI <sup>2</sup>	AICTRL3	Application control register 3

<sup>1</sup> This is the worst-case time that DREQ stays low after writing to this register. The user may choose to skip the DREQ check for those register writes that take less than 100 clock cycles to execute.

<sup>2</sup> In addition, the cycles spent in the user application routine must be counted.

<sup>3</sup> Firmware changes the value of this register immediately to 0x38, and in less than 100 ms to 0x30.

<sup>4</sup> When mode register write specifies a software reset the worst-case time is 16600 XTALI cycles.

<sup>5</sup> Writing to this register may force internal clock to run at  $1.0 \times XTALI$  for a while. Thus it is not a good idea to send SCI or SDI bits while this register update is in progress.

Note that if DREQ is low when an SCI write is done, DREQ also stays low after SCI write processing.



## 8.6.1 SCI\_MODE (RW)

SCI\_MODE is used to control the operation of VS1003 and defaults to 0x0800 (SM\_SDINEW set).

Bit	Name	Function	Value	Description
0	SM_DIFF	Differential	0 1	normal in-phase audio left channel inverted
1	SM_SETTOZERO	Set to zero	0 1	right wrong
2	SM_RESET	Soft reset	0 1	no reset reset
3	SM_OUTOFWAV	Jump out of WAV decoding	0 1	no yes
4	SM_PDOWN	Powerdown	0 1	power on powerdown
5	SM_TESTS	Allow SDI tests	0 1	not allowed allowed
6	SM_STREAM	Stream mode	0 1	no yes
7	SM_SETTOZERO2	Set to zero	0 1	right wrong
8	SM_DACT	DCLK active edge	0 1	rising falling
9	SM_SDIORD	SDI bit order	0 1	MSb first MSb last
10	SM_SDISHARE	Share SPI chip select	0 1	no yes
11	SM_SDINEW	VS10xx native SPI modes	0 1	no yes
12	SM_ADPCM	ADPCM recording active	0 1	no yes
13	SM_ADPCM_HP	ADPCM high-pass filter active	0 1	no yes
14	SM_LINE_IN	ADPCM recording selector	0 1	microphone line in

When SM\_DIFF is set, the player inverts the left channel output. For a stereo input this creates virtual surround, and for a mono input this creates a differential left/right signal.

Software reset is initiated by setting SM\_RESET to 1. This bit is cleared automatically.

If you want to stop decoding a WAV, WMA, or MIDI file in the middle, set SM\_OUTOFWAV, and send data honouring DREQ until SM\_OUTOFWAV is cleared. SCI\_HDAT1 will also be cleared. For WMA and MIDI it is safest to continue sending the stream, send zeroes for WAV.

Bit SM\_PDOWN sets VS1003 into software powerdown mode. Note that software powerdown is not nearly as power efficient as hardware powerdown activated with the XRESET pin.

If SM\_TESTS is set, SDI tests are allowed. For more details on SDI tests, look at Chapter 9.8.

SM\_STREAM activates VS1003's stream mode. In this mode, data should be sent with as even intervals as possible (and preferable with data blocks of less than 512 bytes), and VS1003 makes every attempt to keep its input buffer half full by changing its playback speed up to 5%. For best quality sound, the average speed error should be within 0.5%, the bitrate should not exceed 160 kbit/s and VBR should not be used. For details, see Application Notes for VS10XX. This mode does not work with WMA files.

SM\_DACT defines the active edge of data clock for SDI. When '0', data is read at the rising edge, when '1', data is read at the falling edge.

When SM\_SDIORD is clear, bytes on SDI are sent as a default MSb first. By setting SM\_SDIORD, the user may reverse the bit order for SDI, i.e. bit 0 is received first and bit 7 last. Bytes are, however, still sent in the default order. This register bit has no effect on the SCI bus.

Setting SM\_SDISHARE makes SCI and SDI share the same chip select, as explained in Chapter 7.2, if also SM\_SDINEW is set.

Setting SM\_SDINEW will activate VS10xx native serial modes as described in Chapters 7.2.1 and 7.4.2. Note, that this bit is set as a default when VS1003 is started up.

By activating SM\_ADPCM and SM\_RESET at the same time, the user will activate IMA ADPCM recording mode. More information is available in the Application Notes for VS10XX.

If SM\_ADPCM\_HP is set at the same time as SM\_ADPCM and SM\_RESET, ADPCM mode will start with a high-pass filter. This may help intelligibility of speech when there is lots of background noise. The difference created to the ADPCM encoder frequency response is as shown in Figure 17.

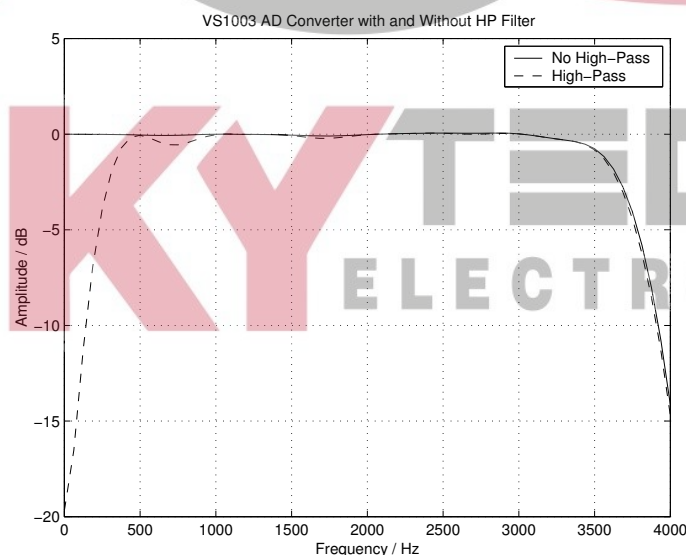

Figure 17: ADPCM Frequency Responses with 8kHz sample rate.

SM\_LINE\_IN is used to select the input for ADPCM recording. If '0', microphone input pins MICP and MICN are used; if '1', LINEIN is used.

## 8.6.2 SCI\_STATUS (RW)

SCI\_STATUS contains information on the current status of VS1003 and lets the user shutdown the chip without audio glitches.

Name	Bits	Description
SS_VER	6:4	Version
SS_APDOWN2	3	Analog driver powerdown
SS_APDOWN1	2	Analog internal powerdown
SS_AVOL	1:0	Analog volume control

SS\_VER is 0 for VS1001, 1 for VS1011, 2 for VS1002 and 3 for VS1003.

SS\_APDOWN2 controls analog driver powerdown. Normally this bit is controlled by the system firmware. However, if the user wants to powerdown VS1003 with a minimum power-off transient, turn this bit to 1, then wait for at least a few milliseconds before activating reset.

SS\_APDOWN1 controls internal analog powerdown. This bit is meant to be used by the system firmware only.

SS\_AVOL is the analog volume control: 0 = -0 dB, 1 = -6 dB, 3 = -12 dB. This register is meant to be used automatically by the system firmware only.

## 8.6.3 SCI\_BASS (RW)

Name	Bits	Description
ST_AMPLITUDE	15:12	Treble Control in 1.5 dB steps (-8..7, 0 = off)
ST_FREQLIMIT	11:8	Lower limit frequency in 1000 Hz steps (0..15)
SB_AMPLITUDE	7:4	Bass Enhancement in 1 dB steps (0..15, 0 = off)
SB_FREQLIMIT	3:0	Lower limit frequency in 10 Hz steps (2..15)

The Bass Enhancer VSBE is a powerful bass boosting DSP algorithm, which tries to take the most out of the users earphones without causing clipping.

VSBE is activated when SB\_AMPLITUDE is non-zero. SB\_AMPLITUDE should be set to the user's preferences, and SB\_FREQLIMIT to roughly 1.5 times the lowest frequency the user's audio system can reproduce. For example setting SCI\_BASS to 0x00f6 will have 15 dB enhancement below 60 Hz.

Note: Because VSBE tries to avoid clipping, it gives the best bass boost with dynamical music material, or when the playback volume is not set to maximum. It also does not create bass: the source material must have some bass to begin with.

Treble Control VSTC is activated when ST\_AMPLITUDE is non-zero. For example setting SCI\_BASS to 0x7a00 will have 10.5 dB treble enhancement at and above 10 kHz.

Bass Enhancer uses about 3.0 MIPS and Treble Control 1.2 MIPS at 44100 Hz sample rate. Both can be on simultaneously.

## 8.6.4 SCI\_CLOCKF (RW)

The operation of SCI\_CLOCKF is different in VS1003 than in VS1001, VS1011, and VS1002.

SCI_CLOCKF bits		
Name	Bits	Description
SC_MULT	15:13	Clock multiplier
SC_ADD	12:11	Allowed multiplier addition
SC_FREQ	10: 0	Clock frequency

SC\_MULT activates the built-in clock multiplier. This will multiply XTALI to create a higher CLKI. The values are as follows:

SC_MULT	MASK	CLKI
0	0x0000	XTALI
1	0x2000	XTALI×1.5
2	0x4000	XTALI×2.0
3	0x6000	XTALI×2.5
4	0x8000	XTALI×3.0
5	0xa000	XTALI×3.5
6	0xc000	XTALI×4.0
7	0xe000	XTALI×4.5

SC\_ADD tells, how much the decoder firmware is allowed to add to the multiplier specified by SC\_MULT if more cycles are temporarily needed to decode a WMA stream. The values are:

SC_ADD	MASK	Multiplier addition
0	0x0000	No modification is allowed
1	0x0800	0.5×
2	0x1000	1.0×
3	0x1800	1.5×

SC\_FREQ is used to tell if the input clock XTALI is running at something else than 12.288 MHz. XTALI is set in 4 kHz steps. The formula for calculating the correct value for this register is  $\frac{XTALI - 8000000}{4000}$  (XTALI is in Hz).

Note: The default value 0 is assumed to mean XTALI=12.288 MHz.

Note: because maximum sample rate is  $\frac{XTALI}{256}$ , all sample rates are not available if XTALI < 12.288 MHz.

Note: Automatic clock change can only happen when decoding WMA files. Automatic clock change is done one 0.5× at a time. This does not cause a drop to 1.0× clock and you can use the same SCI and SDI clock throughout the WMA file. When decoding ends the default multiplier is restored and can cause 1.0× clock to be used momentarily.

Example: If SCI\_CLOCKF is 0x9BE8, SC\_MULT = 4, SC\_ADD = 3 and SC\_FREQ = 0x3E8 = 1000. This means that XTALI = 1000 × 4000 + 8000000 = 12 MHz. The clock multiplier is set to 3.0×XTALI = 36 MHz, and the maximum allowed multiplier that the firmware may automatically choose to use is (3.0 + 1.5)×XTALI = 54 MHz.



## 8.6.5 SCI\_DECODE\_TIME (RW)

When decoding correct data, current decoded time is shown in this register in full seconds.

The user may change the value of this register. In that case the new value should be written twice.

SCI\_DECODE\_TIME is reset at every software reset and also when WAV (PCM or IMA AD-PCM), WMA, or MIDI decoding starts or ends.

## 8.6.6 SCI\_AUDATA (RW)

When decoding correct data, the current sample rate and number of channels can be found in bits 15:1 and 0 of SCI\_AUDATA, respectively. Bits 15:1 contain the sample rate divided by two, and bit 0 is 0 for mono data and 1 for stereo. Writing to SCI\_AUDATA will change the sample rate directly.

Note: due to a bug, an odd sample rate reverses the operation of the stereo bit in VS1003b.

Example: 44100 Hz stereo data reads as 0xAC45 (44101).

Example: 11025 Hz mono data reads as 0x2B10 (11025).

Example: 11025 Hz stereo data reads as 0x2B11 (11026).

Example: Writing 0xAC80 sets sample rate to 44160 Hz, stereo mode does not change.

## 8.6.7 SCI\_WRAM (RW)

SCI\_WRAM is used to upload application programs and data to instruction and data RAMs. The start address must be initialized by writing to SCI\_WRAMADDR prior to the first write/read of SCI\_WRAM. As 16 bits of data can be transferred with one SCI\_WRAM write/read, and the instruction word is 32 bits long, two consecutive writes/reads are needed for each instruction word. The byte order is big-endian (i.e. most significant words first). After each full-word write/read, the internal pointer is autoincremented.

## 8.6.8 SCI\_WRAMADDR (W)

SCI\_WRAMADDR is used to set the program address for following SCI\_WRAM writes/reads. Address offset of 0 is used for X, 0x4000 for Y, and 0x8000 for instruction memory. Peripheral registers can also be accessed.

SM_WRAMADDR Start... End	Dest. addr. Start... End	Bits/ Word	Description
0x1800...0x187F	0x1800...0x187F	16	X data RAM
0x5800...0x587F	0x1800...0x187F	16	Y data RAM
0x8030...0x84FF	0x0030...0x04FF	32	Instruction RAM
0xC000...0xFFFF	0xC000...0xFFFF	16	I/O

Only user areas in X, Y, and instruction memory are listed above. Other areas can be accessed, but should not be written to unless otherwise specified.



## 8.6.9 SCI\_HDAT0 and SCI\_HDAT1 (R)

For WAV files, SCI\_HDAT0 and SCI\_HDAT1 read as 0x7761, and 0x7665, respectively.

For WMA files, SCI\_HDAT1 contains 0x574D and SCI\_HDAT0 contains the data speed measured in bytes per second. To get the bit-rate of the file, multiply the value of SCI\_HDAT0 by 8.

for MIDI files, SCI\_HDAT1 contains 0x4D54 and SCI\_HDAT0 contains values according to the following table:

HDAT0[15:8]	HDAT0[7:0]	Value	Explanation
0	polyphony		current polyphony
1..255	<i>reserved</i>		

For MP3 files, SCI\_HDAT[0... 1] have the following content:

Bit	Function	Value	Explanation
HDAT1[15:5]	syncword	2047	stream valid
HDAT1[4:3]	ID	3	ISO 11172-3 MPG 1.0
		2	ISO 13818-3 MPG 2.0 (1/2-rate)
		1	MPG 2.5 (1/4-rate)
		0	MPG 2.5 (1/4-rate)
HDAT1[2:1]	layer	3	I
		2	II
		1	III
		0	reserved
HDAT1[0]	protect bit	1	No CRC
		0	CRC protected
HDAT0[15:12]	bitrate		ISO 11172-3
HDAT0[11:10]	sample rate	3	reserved
		2	32/16/ 8 kHz
		1	48/24/12 kHz
		0	44/22/11 kHz
HDAT0[9]	pad bit	1	additional slot
		0	normal frame
HDAT0[8]	private bit		not defined
HDAT0[7:6]	mode	3	mono
		2	dual channel
		1	joint stereo
		0	stereo
HDAT0[5:4]	extension		ISO 11172-3
HDAT0[3]	copyright	1	copyrighted
		0	free
HDAT0[2]	original	1	original
		0	copy
HDAT0[1:0]	emphasis	3	CCITT J.17
		2	reserved
		1	50/15 microsec
		0	none

When read, SCI\_HDAT0 and SCI\_HDAT1 contain header information that is extracted from MP3 stream currently being decoded. After reset both registers are cleared, indicating no data has been found yet.

The “sample rate” field in SCI\_HDAT0 is interpreted according to the following table:

“sample rate”	ID=3 / Hz	ID=2 / Hz	ID=0,1 / Hz
3	-	-	-
2	32000	16000	8000
1	48000	24000	12000
0	44100	22050	11025

The “bitrate” field in HDAT0 is read according to the following table:

“bitrate”	ID=3 / kbit/s	ID=0,1,2 / kbit/s
15	forbidden	forbidden
14	320	160
13	256	144
12	224	128
11	192	112
10	160	96
9	128	80
8	112	64
7	96	56
6	80	48
5	64	40
4	56	32
3	48	24
2	40	16
1	32	8
0	-	-

### 8.6.10 SCI\_AIADDR (RW)

SCI\_AIADDR indicates the start address of the application code written earlier with SCI\_WRAMADDR and SCI\_WRAM registers. If no application code is used, this register should not be initialized, or it should be initialized to zero. For more details, see Application Notes for VS10XX.

## 8.6.11 SCI\_VOL (RW)

SCI\_VOL is a volume control for the player hardware. For each channel, a value in the range of 0..254 may be defined to set its attenuation from the maximum volume level (in 0.5 dB steps). The left channel value is then multiplied by 256 and the values are added. Thus, maximum volume is 0 and total silence is 0xFEFE.

Example: for a volume of -2.0 dB for the left channel and -3.5 dB for the right channel:  $(4 * 256) + 7 = 0x407$ . Note, that at startup volume is set to full volume. Resetting the software does not reset the volume setting.

Note: Setting SCI\_VOL to 0xFFFF will activate analog powerdown mode.

## 8.6.12 SCI\_AICTRL[x] (RW)

SCI\_AICTRL[x] registers (  $x=[0..3]$  ) can be used to access the user's application program.



## 9 Operation

### 9.1 Clocking

VS1003 operates on a single, nominally 12.288 MHz fundamental frequency master clock. This clock can be generated by external circuitry (connected to pin XTALI) or by the internal clock crystal interface (pins XTALI and XTALO).

### 9.2 Hardware Reset

When the XRESET -signal is driven low, VS1003 is reset and all the control registers and internal states are set to the initial values. XRESET-signal is asynchronous to any external clock. The reset mode doubles as a full-powerdown mode, where both digital and analog parts of VS1003 are in minimum power consumption stage, and where clocks are stopped. Also XTALO is grounded.

After a hardware reset (or at power-up) DREQ will stay down for at least 16600 clock cycles, which means an approximate 1.35 ms delay if VS1003 is run at 12.288 MHz. After this the user should set such basic software registers as SCI\_MODE, SCI\_BASS, SCI\_CLOCKF, and SCI\_VOL before starting decoding. See section 8.6 for details.

Internal clock can be multiplied with a PLL. Supported multipliers through the SCI\_CLOCKF register are  $1.0 \times \dots 4.5 \times$  the input clock. Reset value for Internal Clock Multiplier is  $1.0 \times$ . If typical values are wanted, the Internal Clock Multiplier needs to be set to  $3.0 \times$  after reset. Wait until DREQ rises, then write value 0x9800 to SCI\_CLOCKF (register 3). See section 8.6.4 for details.

### 9.3 Software Reset

In some cases the decoder software has to be reset. This is done by activating bit 2 in SCI\_MODE register (Chapter 8.6.1). Then wait for at least  $2 \mu\text{s}$ , then look at DREQ. DREQ will stay down for at least 16600 clock cycles, which means an approximate 1.35 ms delay if VS1003 is run at 12.288 MHz. After DREQ is up, you may continue playback as usual.

If you want to make sure VS1003 doesn't cut the ending of low-bitrate data streams and you want to do a software reset, it is recommended to feed 2048 zeros (honoring DREQ) to the SDI bus after the file and before the reset. This is especially important for MIDI files, although you can also use SCI\_HDAT1 polling.

If you want to interrupt the playing of a WAV, WMA, or MIDI file in the middle, set SM\_OUTOFWAV in the mode register, and wait until SCI\_HDAT1 is cleared (with a two-second timeout) before continuing with a software reset. MP3 does not currently implement the SM\_OUTOFWAV because it is a stream format, thus the timeout requirement.

## 9.4 ADPCM Recording

This chapter explains how to create RIFF/WAV file with IMA ADPCM format. This is a widely supported ADPCM format and many PC audio playback programs can play it. IMA ADPCM recording gives roughly a compression ratio of 4:1 compared to linear, 16-bit audio. This makes it possible to record 8 kHz audio at 32.44 kbit/s.

### 9.4.1 Activating ADPCM mode

IMA ADPCM recording mode is activated by setting bits SM\_RESET and SM\_ADPCM in SCI\_MODE. Optionally a high-pass-filter can be enabled for 8 kHz sample rate by also setting SM\_ADPCM\_HP at the same time. Line input is used instead of mic if SM\_LINE\_IN is set. Before activating ADPCM recording, user **must** write a clock divider value to SCI\_AICTRL0 and gain to SCI\_AICTRL1.

The differences of using SM\_ADPCM\_HP are presented in figure 17 (page 30). As a general rule, audio will be fuller and closer to original if SM\_ADPCM\_HP is not used. However, speech may be more intelligible with the high-pass filter active. Use the filter only with 8 kHz sample rate.

Before activating ADPCM recording, user should write a clock divider value to SCI\_AICTRL0. The sampling frequency is calculated from the following formula:  $f_s = \frac{F_c}{256 \times d}$ , where  $F_c$  is the internal clock (CLKI) and  $d$  is the divider value in SCI\_AICTRL0. The lowest valid value for  $d$  is 4. If SCI\_AICTRL0 contains 0, the default divider value 12 is used.

Examples:

$$F_c = 2.0 \times 12.288 \text{ MHz}, d = 12. \text{ Now } f_s = \frac{2.0 \times 12288000}{256 \times 12} = 8000 \text{ Hz.}$$

$$F_c = 2.5 \times 14.745 \text{ MHz}, d = 18. \text{ Now } f_s = \frac{2.5 \times 14745000}{256 \times 18} = 8000 \text{ Hz.}$$

$$F_c = 2.5 \times 13 \text{ MHz}, d = 16. \text{ Now } f_s = \frac{2.5 \times 13000000}{256 \times 16} = 7935 \text{ Hz.}$$

Also, before activating ADPCM mode, the user has to set linear recording gain control to register SCI\_AICTRL1. 1024 is equal to digital gain 1, 512 is equal to digital gain 0.5 and so on. If the user wants to use automatic gain control (AGC), SCI\_AICTRL1 should be set to 0. Typical speech applications usually are better off using AGC, as this takes care of relatively uniform speech loudness in recordings.

Since VS1033c SCI\_AICTRL2 controls the maximum AGC gain. If SCI\_AICTRL2 is zero, the maximum gain is 65535 (64×), i.e. whole range is used. This is compatible with previous operation.

### 9.4.2 Reading IMA ADPCM Data

After IMA ADPCM recording has been activated, registers SCI\_HDAT0 and SCI\_HDAT1 have new functions.

The IMA ADPCM sample buffer is 1024 16-bit words. The fill status of the buffer can be read from SCI\_HDAT1. If SCI\_HDAT1 is greater than 0, you can read as many 16-bit words from SCI\_HDAT0. If the data is not read fast enough, the buffer overflows and returns to empty state.



Note: if  $SCI\_HDAT1 \geq 896$ , it may be better to wait for the buffer to overflow and clear before reading samples. That way you may avoid buffer aliasing.

Each IMA ADPCM block is 128 words, i.e. 256 bytes. If you wish to interrupt reading data and possibly continue later, please stop at a 128-word boundary. This way whole blocks are skipped and the encoded stream stays valid.

### 9.4.3 Adding a RIFF Header

To make your IMA ADPCM file a RIFF / WAV file, you have to add a header before the actual data. Note that 2- and 4-byte values are little-endian (lowest byte first) in this format:

File Offset	Field Name	Size	Bytes	Description
0	ChunkID	4	"RIFF"	
4	ChunkSize	4	F0 F1 F2 F3	File size - 8
8	Format	4	"WAVE"	
12	SubChunk1ID	4	"fmt "	
16	SubChunk1Size	4	0x14 0x0 0x0 0x0	20
20	AudioFormat	2	0x11 0x0	0x11 for IMA ADPCM
22	NumOfChannels	2	0x1 0x0	Mono sound
24	SampleRate	4	R0 R1 R2 R3	0x1f40 for 8 kHz
28	ByteRate	4	B0 B1 B2 B3	0xfd7 for 8 kHz
32	BlockAlign	2	0x0 0x1	0x100
34	BitsPerSample	2	0x4 0x0	4-bit ADPCM
36	ByteExtraData	2	0x2 0x0	2
38	ExtraData	2	0xf9 0x1	Samples per block (505)
40	SubChunk2ID	4	"fact"	
44	SubChunk2Size	4	0x4 0x0 0x0 0x0	4
48	NumOfSamples	4	S0 S1 S2 S3	
52	SubChunk3ID	4	"data"	
56	SubChunk3Size	4	D0 D1 D2 D3	Data size (File Size-60)
60	Block1	256		First ADPCM block
316	...			More ADPCM data blocks

If we have  $n$  audio blocks, the values in the table are as follows:

$$F = n \times 256 + 52$$

$$R = F_s \text{ (see Chapter 9.4.1 to see how to calculate } F_s \text{)}$$

$$B = \frac{F_s \times 256}{505}$$

$$S = n \times 505. \quad D = n \times 256$$

If you know beforehand how much you are going to record, you may fill in the complete header before any actual data. However, if you don't know how much you are going to record, you have to fill in the header size datas  $F$ ,  $S$  and  $D$  after finishing recording.

The 128 words (256 bytes) of an ADPCM block are read from  $SCI\_HDAT0$  and written into file as follows. The high 8 bits of  $SCI\_HDAT0$  should be written as the first byte to a file, then the low 8 bits. Note that this is contrary to the default operation of some 16-bit microcontrollers, and you may have to take extra care to do this right.

A way to see if you have written the file in the right way is to check bytes 2 and 3 (the first byte counts as byte 0) of each 256-byte block. Byte 3 should always be zero.

#### 9.4.4 Playing ADPCM Data

In order to play back your IMA ADPCM recordings, you have to have a file with a header as described in Chapter 9.4.3. If this is the case, all you need to do is to provide the ADPCM file through SDI as you would with any audio file.

#### 9.4.5 Sample Rate Considerations

VS10xx chips that support IMA ADPCM playback are capable of playing back ADPCM files with any sample rate. However, some other programs may expect IMA ADPCM files to have some exact sample rates, like 8000 or 11025 Hz. Also, some programs or systems do not support sample rates below 8000 Hz.

However, if you don't have an appropriate clock, you may not be able to get an exact 8 kHz sample rate. If you have a 12 MHz clock, the closest sample rate you can get with  $2.0 \times 12 \text{ MHz}$  and  $d = 12$  is  $f_s = 7812.5 \text{ Hz}$ . Because the frequency error is only 2.4%, it may be best to set  $f_s = 8000 \text{ Hz}$  to the header if the same file is also to be played back with an PC. This causes the sample to be played back a little faster (one minute is played in 59 seconds).

Note, however, that unless absolutely necessary, sample rates should not be tweaked in the way described here.

If you want better quality with the expense of increased data rate, you can use higher sample rates, for example 16 kHz.

#### 9.4.6 Example Code

The following code initializes IMA ADPCM encoding on VS1003b/VS1023 and shows how to read the data.

```
const unsigned char header[] = {
    0x52, 0x49, 0x46, 0x46, 0x1c, 0x10, 0x00, 0x00,
    0x57, 0x41, 0x56, 0x45, 0x66, 0x6d, 0x74, 0x20, /*|RIFF...WAVEfmt |*/
    0x14, 0x00, 0x00, 0x00, 0x11, 0x00, 0x01, 0x00,
    0x40, 0x1f, 0x00, 0x00, 0x75, 0x12, 0x00, 0x00, /*|.....@...E...|*/
    0x00, 0x01, 0x04, 0x00, 0x02, 0x00, 0xf9, 0x01,
    0x66, 0x61, 0x63, 0x74, 0x04, 0x00, 0x00, 0x00, /*|.....ù.fact....|*/
    0x5c, 0x1f, 0x00, 0x00, 0x64, 0x61, 0x74, 0x61,
    0xe8, 0x0f, 0x00, 0x00
};

unsigned char db[512]; /* data buffer for saving to disk */
```

```

void RecordAdpcm1003(void) { /* VS1003b/VS1033c */
    u_int16 w = 0, idx = 0;

    ... /* Check and locate free space on disk */

    SetMp3Vol(0x1414); /* Recording monitor volume */
    WriteMp3SpiReg(SCI_BASS, 0); /* Bass/treble disabled */

    WriteMp3SpiReg(SCI_CLOCKF, 0x4430); /* 2.0x 12.288MHz */
    Wait(100);
    WriteMp3SpiReg(SCI_AICTRL0, 12); /* Div -> 12=8kHz 8=12kHz 6=16kHz */
    Wait(100);
    WriteMp3SpiReg(SCI_AICTRL1, 0); /* Auto gain */
    Wait(100);
    if (line_in) {
        WriteMp3SpiReg(SCI_MODE, 0x5804); /* Normal SW reset + other bits */
    } else {
        WriteMp3SpiReg(SCI_MODE, 0x1804); /* Normal SW reset + other bits */
    }
    for (idx=0; idx < sizeof(header); idx++) { /* Save header first */
        db[idx] = header[idx];
    }
    /* Fix rate if needed */
    /*db[24] = rate;*/
    /*db[25] = rate>>8;*/

    /* Record loop */
    while (recording_on) {
        do {
            w = ReadMp3SpiReg(SCI_HDAT1);
        } while (w < 256 || w >= 896); /* wait until 512 bytes available */

        while (idx < 512) {
            w = ReadMp3SpiReg(SCI_HDAT0);
            db[idx++] = w>>8;
            db[idx++] = w&0xFF;
        }
        idx = 0;
        write_block(datasector++, db); /* Write output block to disk */
    }
    ... /* Fix WAV header information */
    ... /* Then update FAT information */
    ResetMP3(); /* Normal reset, restore default settings */
    SetMp3Vol(vol);
}

```

## 9.5 SPI Boot

If GPIO0 is set with a pull-up resistor to 1 at boot time, VS1003 tries to boot from external SPI memory.

SPI boot redefines the following pins:

Normal Mode	SPI Boot Mode
GPIO0	xCS
GPIO1	CLK
DREQ	MOSI
GPIO2	MISO

The memory has to be an SPI Bus Serial EEPROM with 16-bit addresses (i.e. at least 1 KiB). The serial speed used by VS1003 is 245 kHz with the nominal 12.288 MHz clock. The first three bytes in the memory have to be 0x50, 0x26, 0x48. The exact record format is explained in the Application Notes for VS10XX.

## 9.6 Play/Decode

This is the normal operation mode of VS1003. SDI data is decoded. Decoded samples are converted to analog domain by the internal DAC. If no decodable data is found, SCI\_HDAT0 and SCI\_HDAT1 are set to 0 and analog outputs are muted.

When there is no input for decoding, VS1003 goes into idle mode (lower power consumption than during decoding) and actively monitors the serial data input for valid data.

All different formats can be played back-to-back without software reset in-between. Send at least 4 zeros after each stream. However, using software reset between streams may still be a good idea, as it guards against broken files. In this case you should wait for the completion of the decoding (SCI\_HDAT0 and SCI\_HDAT1 become zero) before issuing software reset.

## 9.7 Feeding PCM data

VS1003 can be used as a PCM decoder by sending to it a WAV file header. If the length sent in the WAV file is 0 or 0xFFFFFFFF, VS1003 will stay in PCM mode indefinitely (or until SM\_OUTOFWAV has been set). 8-bit linear and 16-bit linear audio is supported in mono or stereo.

## 9.8 SDI Tests

There are several test modes in VS1003, which allow the user to perform memory tests, SCI bus tests, and several different sine wave tests.

All tests are started in a similar way: VS1003 is hardware reset, SM\_TESTS is set, and then a test command is sent to the SDI bus. Each test is started by sending a 4-byte special command sequence, followed by 4 zeros. The sequences are described below.

### 9.8.1 Sine Test

Sine test is initialized with the 8-byte sequence 0x53 0xEF 0x6E  $n$  0 0 0 0, where  $n$  defines the sine test to use.  $n$  is defined as follows:

$n$ bits		
Name	Bits	Description
$F_sIdx$	7:5	Sample rate index
$S$	4:0	Sine skip speed

$F_sIdx$	$F_s$
0	44100 Hz
1	48000 Hz
2	32000 Hz
3	22050 Hz
4	24000 Hz
5	16000 Hz
6	11025 Hz
7	12000 Hz

The frequency of the sine to be output can now be calculated from  $F = F_s \times \frac{S}{128}$ .

Example: Sine test is activated with value 126, which is 0b01111110. Breaking  $n$  to its components,  $F_sIdx = 0b011 = 3$  and thus  $F_s = 22050Hz$ .  $S = 0b11110 = 30$ , and thus the final sine frequency  $F = 22050Hz \times \frac{30}{128} \approx 5168Hz$ .

To exit the sine test, send the sequence 0x45 0x78 0x69 0x74 0 0 0 0.

Note: Sine test signals go through the digital volume control, so it is possible to test channels separately.



## 9.8.2 Pin Test

Pin test is activated with the 8-byte sequence 0x50 0xED 0x6E 0x54 0 0 0 0. This test is meant for chip production testing only.

## 9.8.3 Memory Test

Memory test mode is initialized with the 8-byte sequence 0x4D 0xEA 0x6D 0x54 0 0 0 0. After this sequence, wait for 500000 clock cycles. The result can be read from the SCI register SCI\_HDAT0, and 'one' bits are interpreted as follows:

Bit(s)	Mask	Meaning
15	0x8000	Test finished
14:7		Unused
6	0x0040	Mux test succeeded
5	0x0020	Good I RAM
4	0x0010	Good Y RAM
3	0x0008	Good X RAM
2	0x0004	Good I ROM
1	0x0002	Good Y ROM
0	0x0001	Good X ROM
	0x807f	All ok

Memory tests overwrite the current contents of the RAM memories.

## 9.8.4 SCI Test

Sci test is initialized with the 8-byte sequence 0x53 0x70 0xEE  $n$  0 0 0 0, where  $n$  is the register number to test. The content of the given register is read and copied to SCI\_HDAT0. If the register to be tested is HDAT0, the result is copied to SCI\_HDAT1.

Example: if  $n$  is 0, contents of SCI register 0 (SCI\_MODE) is copied to SCI\_HDAT0.

## 10 VS1003 Registers

### 10.1 Who Needs to Read This Chapter

User software is required when a user wishes to add some own functionality like DSP effects to VS1003.

However, most users of VS1003 don't need to worry about writing their own code, or about this chapter, including those who only download software plug-ins from VLSI Solution's Web site.

### 10.2 The Processor Core

VS\_DSP is a 16/32-bit DSP processor core that also had extensive all-purpose processor features. VLSI Solution's free VSKIT Software Package contains all the tools and documentation needed to write, simulate and debug Assembly Language or Extended ANSI C programs for the VS\_DSP processor core. VLSI Solution also offers a full Integrated Development Environment VSIDE for full debug capabilities.

### 10.3 VS1003 Memory Map

VS1003's Memory Map is shown in Figure 18.

### 10.4 SCI Registers

SCI registers described in Chapter 8.6 can be found here between 0xC000..0xC00F. In addition to these registers, there is one in address 0xC010, called SCI\_CHANGE.

SCI registers, prefix SCI_				
Reg	Type	Reset	Abbrev[bits]	Description
0xC010	r	0	CHANGE[5:0]	Last SCI access address.

SCI_CHANGE bits		
Name	Bits	Description
SCI_CH_WRITE	4	1 if last access was a write cycle.
SCI_CH_ADDR	3:0	SPI address of last access.

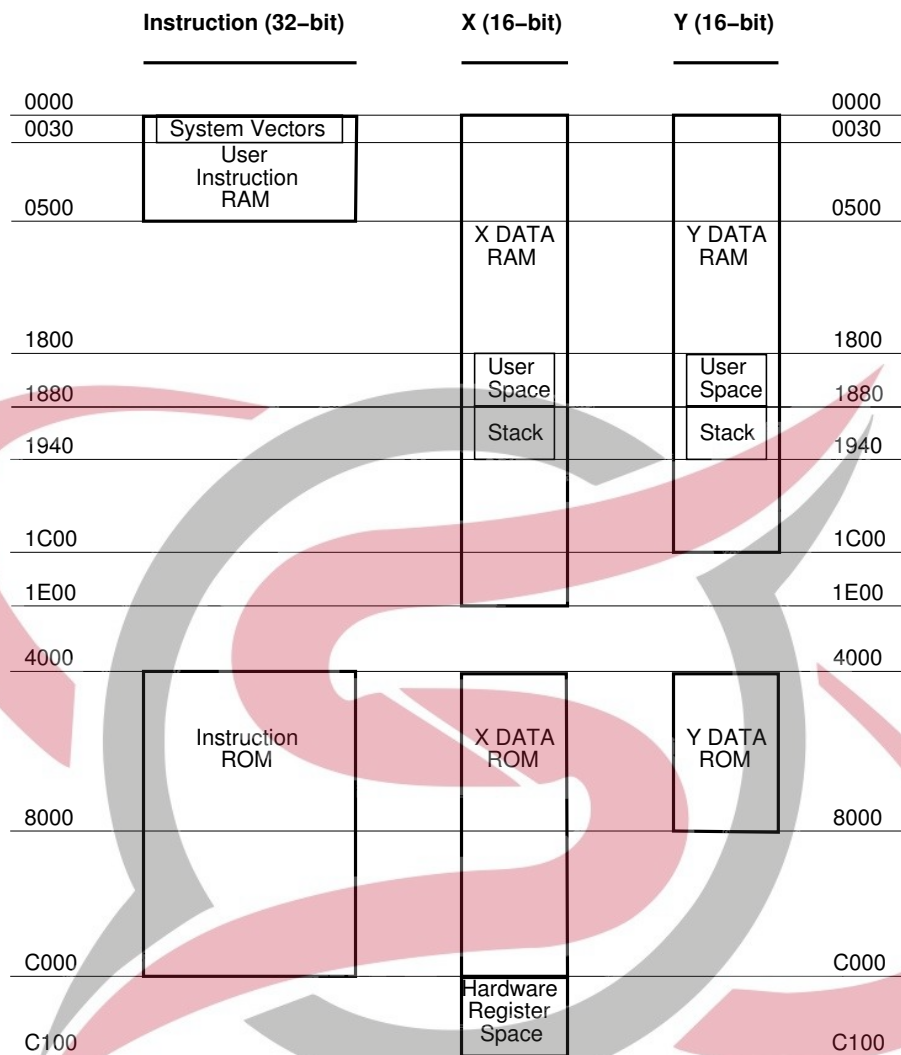

Figure 18: User's Memory Map.

## 10.5 Serial Data Registers

SDI registers, prefix SER_				
Reg	Type	Reset	Abbrev[bits]	Description
0xC011	r	0	DATA	Last received 2 bytes, big-endian.
0xC012	w	0	DREQ[0]	DREQ pin control.

## 10.6 DAC Registers

DAC registers, prefix DAC_				
Reg	Type	Reset	Abbrev[bits]	Description
0xC013	rw	0	FCTLL	DAC frequency control, 16 LSbs.
0xC014	rw	0	FCTLH	DAC frequency control 4MSbs, PLL control.
0xC015	rw	0	LEFT	DAC left channel PCM value.
0xC016	rw	0	RIGHT	DAC right channel PCM value.

Every fourth clock cycle, an internal 26-bit counter is added to by  $(DAC\_FCTLH \& 15) \times 65536 + DAC\_FCTLL$ . Whenever this counter overflows, values from DAC\_LEFT and DAC\_RIGHT are read and a DAC interrupt is generated.

## 10.7 GPIO Registers

GPIO registers, prefix GPIO_				
Reg	Type	Reset	Abbrev[bits]	Description
0xC017	rw	0	DDR[3:0]	Direction.
0xC018	r	0	IDATA[3:0]	Values read from the pins.
0xC019	rw	0	ODATA[3:0]	Values set to the pins.

GPIO\_DIR is used to set the direction of the GPIO pins. 1 means output. GPIO\_ODATA remembers its values even if a GPIO\_DIR bit is set to input.

GPIO registers don't generate interrupts.

Note that in VS1003 the VSDSP registers can be read and written through the SCI\_WRAMADDR and SCI\_WRAM registers. You can thus use the GPIO pins quite conveniently.

**SKY** **TECH**  
ELECTRONIC

## 10.8 Interrupt Registers

Interrupt registers, prefix INT_				
Reg	Type	Reset	Abbrev[bits]	Description
0xC01A	rw	0	ENABLE[7:0]	Interrupt enable.
0xC01B	w	0	GLOB_DIS[-]	Write to add to interrupt counter.
0xC01C	w	0	GLOB_ENA[-]	Write to subtract from interrupt counter.
0xC01D	rw	0	COUNTER[4:0]	Interrupt counter.

INT\_ENABLE controls the interrupts. The control bits are as follows:

INT_ENABLE bits		
Name	Bits	Description
INT_EN_TIM1	7	Enable Timer 1 interrupt.
INT_EN_TIM0	6	Enable Timer 0 interrupt.
INT_EN_RX	5	Enable UART RX interrupt.
INT_EN_TX	4	Enable UART TX interrupt.
INT_EN_MODU	3	Enable AD modulator interrupt.
INT_EN_SDI	2	Enable Data interrupt.
INT_EN_SCI	1	Enable SCI interrupt.
INT_EN_DAC	0	Enable DAC interrupt.

Note: It may take up to 6 clock cycles before changing INT\_ENABLE has any effect.

Writing any value to INT\_GLOB\_DIS adds one to the interrupt counter INT\_COUNTER and effectively disables all interrupts. It may take up to 6 clock cycles before writing to this register has any effect.

Writing any value to INT\_GLOB\_ENA subtracts from the interrupt counter (unless INT\_COUNTER already was 0). If the interrupt counter becomes zero, interrupts selected with INT\_ENABLE are restored. An interrupt routine should always write to this register as the last thing it does, because interrupts automatically add one to the interrupt counter, but subtracting it back to its initial value is the responsibility of the user. It may take up to 6 clock cycles before writing this register has any effect.

By reading INT\_COUNTER the user may check if the interrupt counter is correct or not. If the register is not 0, interrupts are disabled.



## 10.9 A/D Modulator Registers

Interrupt registers, prefix AD_				
Reg	Type	Reset	Abbrev[bits]	Description
0xC01E	rw	0	DIV	A/D Modulator divider.
0xC01F	rw	0	DATA	A/D Modulator data.

AD\_DIV controls the AD converter's sampling frequency. To gather one sample,  $128 \times n$  clock cycles are used ( $n$  is value of AD\_DIV). The lowest usable value is 4, which gives a 48 kHz sample rate when CLKI is 24.576 MHz. When AD\_DIV is 0, the A/D converter is turned off.

AD\_DATA contains the latest decoded A/D value.



## 10.10 Watchdog

The watchdog consist of a watchdog counter and some logic. After reset, the watchdog is inactive. The counter reload value can be set by writing to WDOG\_CONFIG. The watchdog is activated by writing 0x4ea9 to register WDOG\_RESET. Every time this is done, the watchdog counter is reset. Every 65536'th clock cycle the counter is decremented by one. If the counter underflows, it will activate vsdsp's internal reset sequence.

Thus, after the first 0x4ea9 write to WDOG\_RESET, subsequent writes to the same register with the same value must be made no less than every  $65536 \times \text{WDOG\_CONFIG}$  clock cycles.

Once started, the watchdog cannot be turned off. Also, a write to WDOG\_CONFIG doesn't change the counter reload value.

After watchdog has been activated, any read/write operation from/to WDOG\_CONFIG or WDOG\_DUMMY will invalidate the next write operation to WDOG\_RESET. This will prevent runaway loops from resetting the counter, even if they do happen to write the correct number. Writing a wrong value to WDOG\_RESET will also invalidate the next write to WDOG\_RESET.

Reads from watchdog registers return undefined values.

### 10.10.1 Registers

Watchdog, prefix WDOG_				
Reg	Type	Reset	Abbrev	Description
0xC020	w	0	CONFIG	Configuration
0xC021	w	0	RESET	Clock configuration
0xC022	w	0	DUMMY[-]	Dummy register

## 10.11 UART (Universal Asynchronous Receiver/Transmitter)

The RS232 UART implements a serial interface using RS232 standard 8N1 (8 data bits, no parity, 1 stop bit).

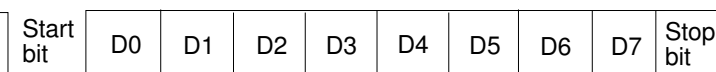

Figure 19: RS232 Serial Interface Protocol

When the line is idling, it stays in logic high state. When a byte is transmitted, the transmission begins with a start bit (logic zero) and continues with data bits (LSB first) and ends up with a stop bit (logic high). 10 bits are sent for each 8-bit byte frame.

### 10.11.1 Registers

UART registers, prefix UARTx_				
Reg	Type	Reset	Abbrev	Description
0xC028	r	0	STATUS[3:0]	Status
0xC029	r/w	0	DATA[7:0]	Data
0xC02A	r/w	0	DATAH[15:8]	Data High
0xC02B	r/w	0	DIV	Divider

### 10.11.2 Status UARTx\_STATUS

A read from the status register returns the transmitter and receiver states.

UARTx_STATUS Bits		
Name	Bits	Description
UART_ST_RXORUN	3	Receiver overrun
UART_ST_RXFULL	2	Receiver data register full
UART_ST_TXFULL	1	Transmitter data register full
UART_ST_TXRUNNING	0	Transmitter running

UART\_ST\_RXORUN is set if a received byte overwrites unread data when it is transferred from the receiver shift register to the data register, otherwise it is cleared.

UART\_ST\_RXFULL is set if there is unread data in the data register.

UART\_ST\_TXFULL is set if a write to the data register is not allowed (data register full).

UART\_ST\_TXRUNNING is set if the transmitter shift register is in operation.

### 10.11.3 Data UARTx\_DATA

A read from UARTx\_DATA returns the received byte in bits 7:0, bits 15:8 are returned as '0'. If there is no more data to be read, the receiver data register full indicator will be cleared.

A receive interrupt will be generated when a byte is moved from the receiver shift register to the receiver data register.

A write to UARTx\_DATA sets a byte for transmission. The data is taken from bits 7:0, other bits in the written value are ignored. If the transmitter is idle, the byte is immediately moved to the transmitter shift register, a transmit interrupt request is generated, and transmission is started. If the transmitter is busy, the UART\_ST\_TXFULL will be set and the byte remains in the transmitter data register until the previous byte has been sent and transmission can proceed.

### 10.11.4 Data High UARTx\_DATAH

The same as UARTx\_DATA, except that bits 15:8 are used.

### 10.11.5 Divider UARTx\_DIV

UARTx_DIV Bits		
Name	Bits	Description
UART_DIV_D1	15:8	Divider 1 (0..255)
UART_DIV_D2	7:0	Divider 2 (6..255)

The divider is set to 0x0000 in reset. The ROM boot code must initialize it correctly depending on the master clock frequency to get the correct bit speed. The second divider ( $D_2$ ) must be from 6 to 255.

The communication speed  $f = \frac{f_m}{(D_1+1) \times (D_2)}$ , where  $f_m$  is the master clock frequency, and  $f$  is the TX/RX speed in bps.

Divider values for common communication speeds at 26 MHz master clock:

Example UART Speeds, $f_m = 26MHz$		
Comm. Speed [bps]	UART_DIV_D1	UART_DIV_D2
4800	85	63
9600	42	63
14400	42	42
19200	51	26
28800	42	21
38400	25	26
57600	1	226
115200	0	226

### 10.11.6 Interrupts and Operation

Transmitter operates as follows: After an 8-bit word is written to the transmit data register it will be transmitted instantly if the transmitter is not busy transmitting the previous byte. When the transmission begins a TX\_INTR interrupt will be sent. Status bit [1] informs the transmitter data register empty (or full state) and bit [0] informs the transmitter (shift register) empty state. A new word must not be written to transmitter data register if it is not empty (bit [1] = '0'). The transmitter data register will be empty as soon as it is shifted to transmitter and the transmission is begun. It is safe to write a new word to transmitter data register every time a transmit interrupt is generated.

Receiver operates as follows: It samples the RX signal line and if it detects a high to low transition, a start bit is found. After this it samples each 8 bit at the middle of the bit time (using a constant timer), and fills the receiver (shift register) LSB first. Finally if a stop bit (logic high) is detected the data in the receiver is moved to the receive data register and the RX\_INTR interrupt is sent and a status bit[2] (receive data register full) is set, and status bit[2] old state is copied to bit[3] (receive data overrun). After that the receiver returns to idle state to wait for a new start bit. Status bit[2] is zeroed when the receiver data register is read.

RS232 communication speed is set using two clock dividers. The base clock is the processor master clock. Bits 15-8 in these registers are for first divider and bits 7-0 for second divider. RX sample frequency is the clock frequency that is input for the second divider.



## 10.12 Timers

There are two 32-bit timers that can be initialized and enabled independently of each other. If enabled, a timer initializes to its start value, written by a processor, and starts decrementing every clock cycle. When the value goes past zero, an interrupt is sent, and the timer initializes to the value in its start value register, and continues downcounting. A timer stays in that loop as long as it is enabled.

A timer has a 32-bit timer register for down counting and a 32-bit TIMER1\_LH register for holding the timer start value written by the processor. Timers have also a 2-bit TIMER\_ENA register. Each timer is enabled (1) or disabled (0) by a corresponding bit of the enable register.

### 10.12.1 Registers

Timer registers, prefix TIMER_				
Reg	Type	Reset	Abbrev	Description
0xC030	r/w	0	CONFIG[7:0]	Timer configuration
0xC031	r/w	0	ENABLE[1:0]	Timer enable
0xC034	r/w	0	T0L	Timer0 startvalue - LSBs
0xC035	r/w	0	T0H	Timer0 startvalue - MSBs
0xC036	r/w	0	T0CNTL	Timer0 counter - LSBs
0xC037	r/w	0	T0CNTH	Timer0 counter - MSBs
0xC038	r/w	0	T1L	Timer1 startvalue - LSBs
0xC039	r/w	0	T1H	Timer1 startvalue - MSBs
0xC03A	r/w	0	T1CNTL	Timer1 counter - LSBs
0xC03B	r/w	0	T1CNTH	Timer1 counter - MSBs

### 10.12.2 Configuration TIMER\_CONFIG

TIMER_CONFIG Bits		
Name	Bits	Description
TIMER_CF_CLKDIV	7:0	Master clock divider

TIMER\_CF\_CLKDIV is the master clock divider for all timer clocks. The generated internal clock frequency  $f_i = \frac{f_m}{c+1}$ , where  $f_m$  is the master clock frequency and  $c$  is TIMER\_CF\_CLKDIV. Example: With a 12 MHz master clock, TIMER\_CF\_DIV=3 divides the master clock by 4, and the output/sampling clock would thus be  $f_i = \frac{12MHz}{3+1} = 3MHz$ .

### 10.12.3 Configuration **TIMER\_ENABLE**

TIMER_ENABLE Bits		
Name	Bits	Description
TIMER_EN_T1	1	Enable timer 1
TIMER_EN_T0	0	Enable timer 0

### 10.12.4 Timer X Startvalue **TIMER\_Tx[L/H]**

The 32-bit start value **TIMER\_Tx[L/H]** sets the initial counter value when the timer is reset. The timer interrupt frequency  $f_t = \frac{f_i}{c+1}$  where  $f_i$  is the master clock obtained with the clock divider (see Chapter 10.12.2 and  $c$  is **TIMER\_Tx[L/H]**).

Example: With a 12 MHz master clock and with **TIMER\_CF\_CLKDIV=3**, the master clock  $f_i = 3MHz$ . If **TIMER\_TH=0**, **TIMER\_TL=99**, then the timer interrupt frequency  $f_t = \frac{3MHz}{99+1} = 30kHz$ .

### 10.12.5 Timer X Counter **TIMER\_TxCNT[L/H]**

**TIMER\_TxCNT[L/H]** contains the current counter values. By reading this register pair, the user may get knowledge of how long it will take before the next timer interrupt. Also, by writing to this register, a one-shot different length timer interrupt delay may be realized.

### 10.12.6 Interrupts

Each timer has its own interrupt, which is asserted when the timer counter underflows.

## 10.13 System Vector Tags

The System Vector Tags are tags that may be replaced by the user to take control over several decoder functions.

### 10.13.1 AudioInt, 0x20

Normally contains the following VS\_DSP assembly code:

```
jmp_i DAC_INT_ADDRESS, (i6)+1
```

The user may, at will, replace the first instruction with a *jmp\_i* command to gain control over the audio interrupt.

### 10.13.2 SciInt, 0x21

Normally contains the following VS\_DSP assembly code:

```
jmp_i SCI_INT_ADDRESS, (i6)+1
```

The user may, at will, replace the instruction with a *jmp\_i* command to gain control over the SCI interrupt.

### 10.13.3 DataInt, 0x22

Normally contains the following VS\_DSP assembly code:

```
jmp_i SDI_INT_ADDRESS, (i6)+1
```

The user may, at will, replace the instruction with a *jmp\_i* command to gain control over the SDI interrupt.

### 10.13.4 Modulnt, 0x23

Normally contains the following VS\_DSP assembly code:

```
jmp_i MODU_INT_ADDRESS, (i6)+1
```

The user may, at will, replace the instruction with a *jmp* command to gain control over the AD Modulator interrupt.

### 10.13.5 TxInt, 0x24

Normally contains the following VS\_DSP assembly code:

```
jmp EMPTY_INT_ADDRESS, (i6)+1
```

The user may, at will, replace the instruction with a *jmp* command to gain control over the UART TX interrupt.

### 10.13.6 RxInt, 0x25

Normally contains the following VS\_DSP assembly code:

```
jmp RX_INT_ADDRESS, (i6)+1
```

The user may, at will, replace the first instruction with a *jmp* command to gain control over the UART RX interrupt.

### 10.13.7 Timer0Int, 0x26

Normally contains the following VS\_DSP assembly code:

```
jmp EMPTY_INT_ADDRESS, (i6)+1
```

The user may, at will, replace the first instruction with a *jmp* command to gain control over the Timer 0 interrupt.

### 10.13.8 Timer1Int, 0x27

Normally contains the following VS\_DSP assembly code:

```
jmp EMPTY_INT_ADDRESS, (i6)+1
```

The user may, at will, replace the first instruction with a *jmp* command to gain control over the Timer 1 interrupt.

## 10.13.9 UserCodec, 0x0

Normally contains the following VS\_DSP assembly code:

```
jr
nop
```

If the user wants to take control away from the standard decoder, the first instruction should be replaced with an appropriate *j* command to user's own code.

Unless the user is feeding MP3 or WMA data at the same time, the system activates the user program in less than 1 ms. After this, the user should steal interrupt vectors from the system, and insert user programs.

## 10.14 System Vector Functions

The System Vector Functions are pointers to some functions that the user may call to help implementing his own applications.

### 10.14.1 WritelRam(), 0x2

VS\_DSP C prototype:

```
void WritelRam(register __i0 u_int16 *addr, register __a1 u_int16 msW, register __a0 u_int16 lsW);
```

This is the preferred way to write to the User Instruction RAM.

### 10.14.2 ReadIRam(), 0x4

VS\_DSP C prototype:

```
u_int32 ReadIRam(register __i0 u_int16 *addr);
```

This is the preferred way to read from the User Instruction RAM.

A1 contains the MSBs and a0 the LSBs of the result.



### 10.14.3 DataBytes(), 0x6

VS\_DSP C prototype:

```
u_int16 DataBytes(void);
```

If the user has taken over the normal operation of the system by switching the pointer in User-Codec to point to his own code, he may read data from the Data Interface through this and the following two functions.

This function returns the number of data bytes that can be read.

### 10.14.4 GetDataByte(), 0x8

VS\_DSP C prototype:

```
u_int16 GetDataByte(void);
```

Reads and returns one data byte from the Data Interface. This function will wait until there is enough data in the input buffer.

### 10.14.5 GetDataWords(), 0xa

VS\_DSP C prototype:

```
void GetDataWords(register __i0 __y u_int16 *d, register __a0 u_int16 n);
```

Read *n* data byte pairs and copy them in big-endian format (first byte to MSBs) to *d*. This function will wait until there is enough data in the input buffer.

### 10.14.6 Reboot(), 0xc

VS\_DSP C prototype:

```
void Reboot(void);
```

Causes a software reboot, i.e. jump to the standard firmware without reinitializing the IRAM vectors.

This is NOT the same as the software reset function, which causes complete initialization.

## 11 Latest Document Version Changes

This chapter describes the latest and most important changes to this document.

### Version 1.09, 2018-03-16

- Added mention of 8N1 format to Chapter 10.11, *UART (Universal Asynchronous Receiver/Transmitter)*.
- Added chip image to last page.
- Removed MP2 and MP3 license descriptions from Chapter 1, *Licenses*, and other relevant places, as all their patents have expired.
- Updated Chapter 3, *Definitions*.
- Other, minor changes.

### Version 1.08, 2014-12-19

- Updated telephone number in Chapter 12, *Contact Information*.

### Version 1.07, 2014-03-11

- VS1003B-LK has been qualified for the same more relaxed CVDD limits as VS1003B-L and VS1003B-B. Because of this, the more strict CVDD limits for VS1003B-LK removed from Chapter 4.1, *Absolute Maximum Ratings*, and Chapter 4.2, *Recommended Operating Conditions*.

### Version 1.06, 2012-03-16

- CVDD limits added for VS1003B-LK in Chapter 4, *Characteristics & Specifications*.

### Version 1.05, 2011-04-13

- SCI Test description fixed.
- CVDD limits changed.

### Version 1.04, 2009-02-03

- Typical characteristics added to section 4.7, some values changed in section 4.3.

## 12 Contact Information

VLSI Solution Oy  
Entrance G, 2nd floor  
Hermiankatu 8  
FI-33720 Tampere  
FINLAND

URL: <http://www.vlsi.fi/>  
Phone: +358-50-462-3200  
Commercial e-mail: [sales@vlsi.fi](mailto:sales@vlsi.fi)

For technical support or suggestions regarding this document, please participate at  
<http://www.vsdsp-forum.com/>  
For confidential technical discussions, contact  
[support@vlsi.fi](mailto:support@vlsi.fi)

